

H.264 NETWORK Embedded DVR

USER MANUAL



CAUTION

RISK OF ELECTRIC SHOCK
DO NOT OPEN



CAUTION: TO REDUCE THE RICK OF ELECTRIC SHOCK DO NOT REMOVE COVER. NO USER SERVICABLE PARTS INSIDE.

REFER SERVICING TO QUALIFIED SERVICE PERSONNEL.



The lightning flash with arrowhead symbol, within an equilateral triangle, is intended to alert the user to the presence of uninsulated "dangerous voltage" within the products' enclosure that may be of sufficient magnitude to constitute a risk of electric shock



The exclamation point within an equilateral triangle is intended to alert the user to the presence of important operating and maintenance (servicing) instructions in the literature accompanying the appliance.

WARNING: TO PREVENT FIRE OR SHOCK HAZARD, DO NOT EXPOSE THIS UNIT TO RAIN OR MOISTURE.

CAUTION: TO PREVENT ELECTRIC SHOCK, MATCH WIDE BLADE OF THE PLUG TO THE WIDE SLOT AND FULLY INSERT.

CONTENT

1	INTRODUCTION	4
1.1	PREODUCT INTRODUCE.....	4
1.2	PRODUCT FEATURE.....	4
1.2.1	<i>SPECIFICATION</i>	4
1.2.2	<i>BASIC WORKING PARAMETER</i>	5
1.3	ENVIRONMENT ADAPTABILITY.....	5
2	DEVICE OPERATION	6
2.1	REMOTE KEY INSTRUCTION.....	6
2.1.1	<i>REMOTE CONTROL</i>	6
2.1.2	<i>MOUSE OPERATION</i>	7
2.1.3	<i>MENU TREE</i>	8
2.2	SYSTEM OPERSTION.....	9
2.2.1	<i>USER LOGIN</i>	9
2.2.2	<i>GUI OPERATION</i>	9
2.2.3	<i>DEVICES SETUP</i>	16
2.2.4	<i>SYSTEM SETUP</i>	23
3	IE OPERATION	28
3.1	FEATURE.....	28
3.2	USER LOGIN.....	28
3.3	OPERATION INTERFACE.....	29
3.3.1	<i>LIVE</i>	29
3.3.1.1	<i>PTZ CONTROL</i>	29
3.3.1.1.1	<i>ZOOM</i>	29
3.3.1.1.2	<i>PTZ PRESET</i>	30
3.3.1.2	<i>PLAY</i>	30
3.3.1.3	<i>OTHER OPERATION</i>	30
3.3.2	<i>REPALY(IE Browser)</i>	30
3.3.3	<i>REMOTE SETTING</i>	32
3.3.3.1	<i>ENCODE SETTING</i>	32
3.3.3.2	<i>RECORD SETTING</i>	34
3.3.3.3	<i>ALARM</i>	35
3.3.3.4	<i>PTZ</i>	35
3.3.3.5	<i>NETWORK</i>	36
3.3.3.6	<i>ADVANCED SETTING</i>	37
3.3.3.7	<i>SYSTEM INFO</i>	39
3.3.3.8	<i>USER SETTING</i>	40
3.3.4	<i>LOCAL SETTING</i>	41
3.3.5	<i>LOGOUT</i>	41
4	DVR INSTALLATION	42
4.1	PRODUCT OVERVIEW.....	42
4.1.1	<i>The Definition of Buttons and Connectors on Front Panel</i>	42
4.1.2	<i>The definition of buttons and connectors on fear panel</i>	43
4.1.3	<i>System Network Diagram</i>	44
4.1.4	<i>Connectors for Alarm</i>	45
4.1.5	<i>Alarm Input and Output</i>	46
4.1.6	<i>System Network Diagram</i>	47
4.2	HDD INSTALLATION.....	48
5	FAQ	51

1 INTRODUCTION

1.1 PREODUCT INTRODUCE

The serial of DVR include 4 channels,8 channels and 16 channels ,that is CIF resolution digital video recording DVR, which have local recording, playback, support triple code remote network surveillance, data backup, parameter setting, motion detection, I/O alarm setting, PTZ and USB mouse, USB2.0 backup, IE browser and back up etc.

1.2 PRODUCT FEATURE

- ◇ H.264 compression
- ◇ Two USB interface, USB2.0 for data backup, USB2.0 for mouse operation.
- ◇ Support 1 pcs 3.5" SATA HDD at most.
- ◇ Special file system for security.
- ◇ 16 bit color translucent user-friendly GUI, with notes for selected menu items
- ◇ Optimized one four channel simultaneously playback
- ◇ double level user management
- ◇ Support the live view, parameter setting and copy playback video via network.

1.2.1 SPECIFICATION

Module	4CH	8CH	16CH
Picture compression	H.264		
Video in	1.0Vp-p/75Ω, BNC×4	1.0Vp-p/75Ω, BNC×8	1.0Vp-p/75Ω, BNC×16
Video out	1.0Vp-p/75Ω, BNC×1; VGA×1		1.0Vp-p/75Ω, BNC×1; SPOTX1;VGA×1
Resolution	Live: D1 Record: 2CH D1, 2CH CIF	Live: D1 Record: 8CH CIF	Live: D1 Record: 1CH D1, 15CH CIF
frame rate	PAL : 100 Fps(CIF) NTSC :120 Fps(CIF)	PAL :200 Fps(CIF) NTSC :240 Fps(CIF)	PAL : 400 Fps(CIF) NTSC : 480 Fps(CIF)
Audio input	RCA×4	RCA×8	RCA×16
Audio output	RCA×1		
Audio codec	ADPCM		
Alarm input	4 alarm input	8 alarm input	16 alarm input
Alarm output	1 alarm output	2 alarm output	2 alarm output
Video mode	Manual recording , Scheduled recording, Movement alarm video and External alarm recording		
Network interface	RJ45,100M/1000M		

PTZ	support		
communication interface	RS485×1, USB2.0×2		RS485×1, RS232×1, USB2.0×,3
Data storage	Support 1 SATA HDD (300GB-2TB)		Support 2 SATA HDD (300GB-2TB)
Mouse	USB Mouse		
Remote control	Support		
voltage input	12V/3A		12V/5A
Appearance	DVR-07	DVR -07	DVR -15

1.2.2 BASIC WORKING PARAMETER

Item	Parameter	Description
Voltage input	12V	DC 12V
Video impedance input	75Ω	75Ω Each channel.
Video output	1Vp-p	1Vp-p CVBS signal
I/O	0—2V	Low voltage alarm
	5V-30v	High voltage alarm
RS232		Serial port, for extend use(16channels)
RS485		Connect to PTZ, (Pelco-D,Pelco-P)
SATA HDD		One SATA HDD with mainstream capability(16 CH support two SATA HDDs)

1.3 ENVIRONMENT ADAPTABILITY

For safety while using the DVR and to prolong device life, please pay attention to the following details:

- 1) When installing device, please comply with all the electric product safety criteria.
- 2) Power and ground:
 - ◆ Do not touch the power and DVR with a wet hand
 - ◆ Do not drop liquid on DVR
 - ◆ Do not put any object on DVR
 - ◆ Please use soft dry cloth to clean DVR; do not use chemical impregnant.
 - ◆ The Device will have voltage before startup if the power line is connected to power Source.
 - ◆ Please unplug power line from power source if the Device is not intended to be used for a prolonged time.

2 DEVICE OPERATION











In device operation, the enter key on remote control has the same function as left click of the mouse.

2.1 REMOTE KEY INSTRUCTION

2.1.1 REMOTE CONTROL

The remote control is the secondary input device
For navigating the system's interface.

To use the remote control:

1. **STANDBY**: Press to turn on/off standby mode.
2. **LOGIN/LOCK**: If "Security" has been enabled in the Setup menu, press to open the user password login screen.
3. **Number/Channel buttons**: While in menus, press buttons 0~9 to enter values; during live viewing, press to view channels in full-screen.
4. : Press to switch between quad and split-screen displays.
5. **MENU**: Opens the main menu.
6. **PTZ**: Press to open the PTZ control window.
7. **EXIT**: Close menu windows.
8. **Navigation/OK**:
 - : Move cursor in menus up, Channel Up
 - : Move cursor in menus right, Channel Up, during playback, increase forward playback speed (2X, 4X, 8X).
 - : Move cursor in menus left, Channel down, during playback, increase reverse playback speed (2X, 4X, 8X)
 - : Move cursor in menus down, Channel down
 - **OK**: In menus, press to confirm selections;
9. **+ / -**: In menus, press to adjust values.
10. **RECORD**: Press to start manual recording.
11. **STOP**: Press to stop manual recording.
12. **EXTRA**: For the future use.
13. **Playback controls**:
 - : Increase reverse playback speed 2X, 4X, 8X;
 - : Press to start playback;
 - : Press to increase forward playback speed 2X, 4X, 8X;
 - : Press to slow playback speed by 1/2, 1/4, 1/8;
 - : Press to freeze playback to one frame, then press again to advance frame-by-frame
14. **AUDIO/MUTE**: Turn on/off audio



TIP: When using the remote control to enter password and camera titles, select the field using the navigation buttons press ENTER, and then press the number buttons.

2.1.2 MOUSE OPERATION

The mouse is the primary input device for navigating system menus.

NOTE: Unless otherwise noted, all system functions described in this manual are achieved through mouse input.

To use a mouse with the system:

- 1) Connect a USB mouse to the **USB MOUSE port** on rear panel of the system.

NOTE: Only the top USB port on the rear panel is designed for data backup to a USB flash drive. Do not connect a USB flash drive to the bottom USB port on the rear panel.

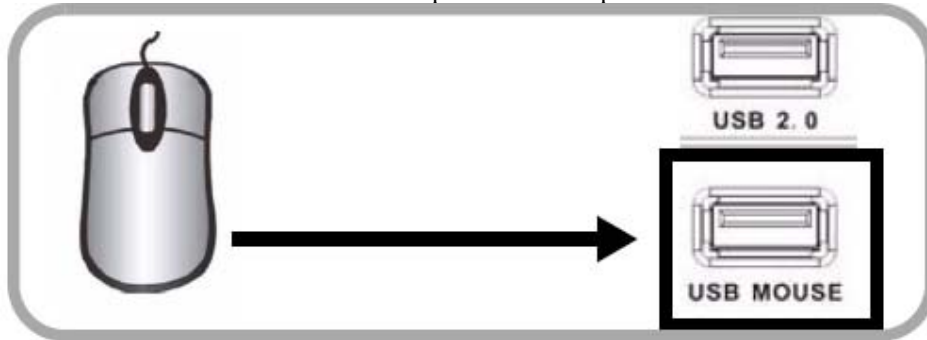

Figure 1.0 Connect a USB mouse to the bottom USB port on therear panel

- 2) Use the mouse buttons to perform the following:
 - **Left-Button:** Click to select a menu option; during live viewing in split-screen, double-click on a channel to view the selected channel in full-screen.; double-click the channel again to return to split-screen view
 - **Right-Button:** Click to open the Sub-Menu
- 3) **Scroll-Wheel:** No function.

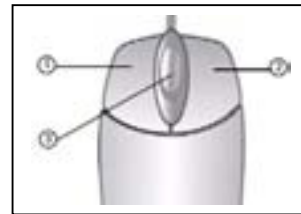
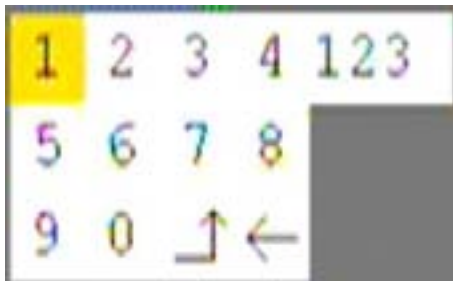

Figure 1.1 Mouse button operation

When using the mouse, you can input certain values using the onscreen virtual keyboard. You will need to use the Virtual Keyboard when entering your User ID and Password.

- 4) Virtual **Keyboard** (Mouse)

To use the Virtual Keyboard:



1. Click on an option or field, such as the User ID and Password fields.

2. Click 0~9 to key-in the desired digit.

3. Click 123 to switch between numerals, upper and lowercase letters, and other characters (only for certain options)

4. Click ← to Backspace/Delete.

NOTE: The buttons will turn from orange to white when you

select the button with the mouse cursor.

5. Click ↵ to enter/confirm and close the Virtual Keyboard.

2.1.3 MENU TREE

You can control the DVR by a lot of menu operation. This tree will show you the menu structure and it will be in details in after chapter.

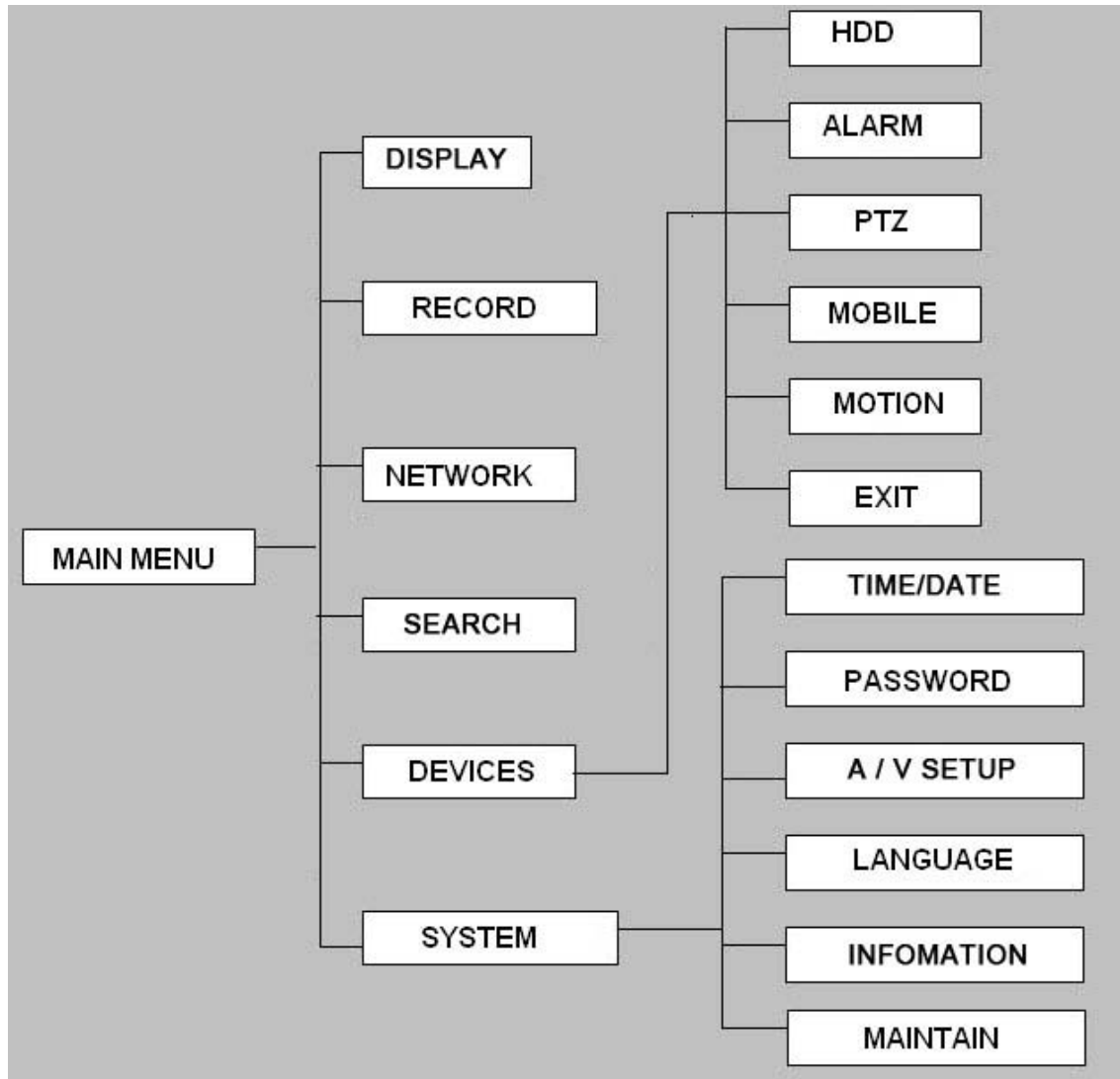

2.2 SYSTEM OPERSTION

2.2.1 USER LOGIN

2.2.1.1 STARTING THE SYSTEM

To power the system ON/OFF:

Connect the power cable to the DC 12V port on the rear panel. At startup, the system performs a basic system check and runs an initial loading sequence. After a few moments, the system loads a live display view.

ATTENTION: By default, passwords are **disabled** on the system. You do not need to enter a password when accessing any system menus. However, for security purposes, it is highly recommended to enable passwords on the system using the Password Menu.

NOTE:

- 1) If there is no HDD in device, or the device didn't read the HDD, or the HDD didn't be formatted it will display an **【H】** in the video preview interface.
- 2) You must format the HDD in the DVR before first using. The steps as follows: MainMenu > Device>HDD management > format. After formatting, the system will restart.

2.2.1.1 SYSTEM LOGIN

When you login, you will find the window as follow if the password is enabled, Input device ID and user password via numeric key-board, and you can access to main menu via press **【Apply】**

Remark: default device ID is: 000000, and the password is :user password is 000000 and Admin password is 519070, in order to manage the device more convenience, please setup the user password and change the device ID in the base setup. You can setup user and admin password, Administrator has all authorities, operator has limited authorities who they can only watch, playback, please change the unit ID and default password in time for system security.



DEVICE ID: You just need to enter the unit ID as the right frame.

PASSWORD: enter the admin password or user password.

2.2.2 GUI OPERATION

The main menu nclude“DISPLAY”,“RECORD”,“NETWORK”,“SEARCH”,“DEVICES”,and“SYSTEM”.

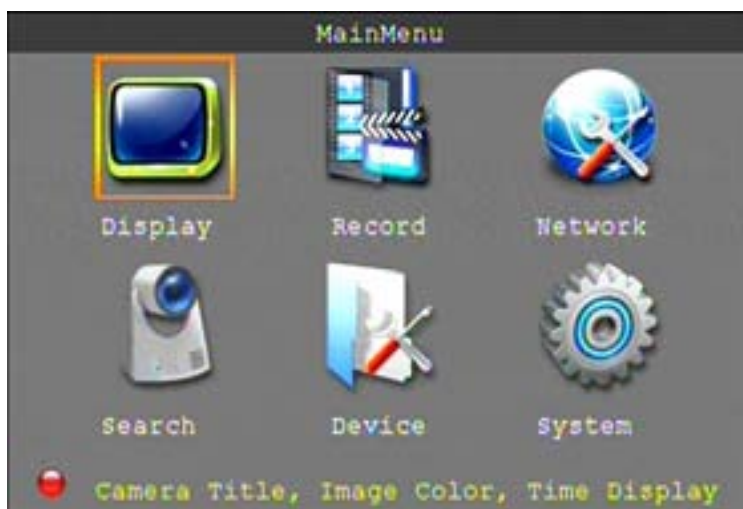

Remark: You must after pressing “APPLY” to make the setting for submenu valid. It will no use when exit directly. This DVR have a special feature is: when you move the mouse to everywhere, there will have the explanation information showed auto.

2.2.2.1 DISPLAY

Move the cursor to **【DISPLAY】** (Icon with the orange box means that selected) , press **【Enter】** to enter into the setting interface.



CH01~CH04: you can select the CH01~CH04,CH05~CH08,CH09~CH12(16CH DVR),CH13~CH16(16CH DVR) here.

CHN NAME: press **【Enter】** to enter into the setting interface.

POSITION: press **【Enter】** to switch name location, there are 5 options.

COLOR: press **【Enter】** to enter into setting interface, as following:

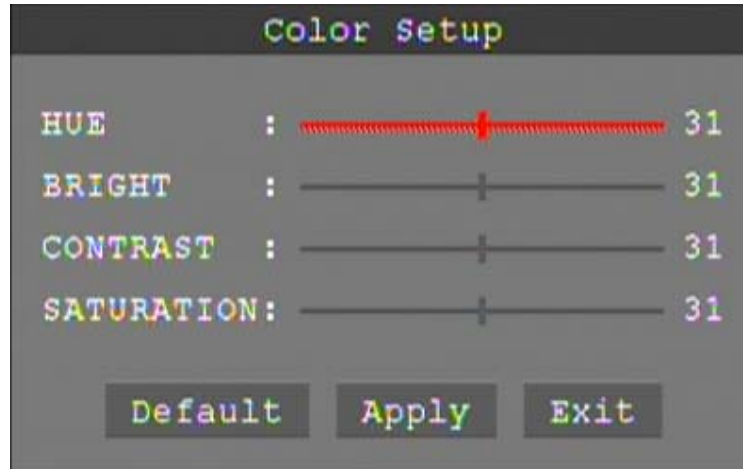

Press **【Enter】** or **【+】** **【-】** key or directly drag the cursor to set colors, including chroma, brightness, contrast and saturation, press **【APPLY】** to save the parameters.

LIVE: Open: Means the channel is allowed to view the live mode, Close means not.

LIVE TIME(display time while in live view): Open: Means yes, Close means not.

RECORD TIME(display time while recording): Open: Means yes, Close means not.

2.2.2.2 RECORD SETUP

Move the cursor to **【RECORD】** (Icon with the orange box means that selected) ,press **【Enter】** to enter into the setting interface. Press **【Confirm】** and enter into the setup interface, and you can use direction keys and cursor to change the options.

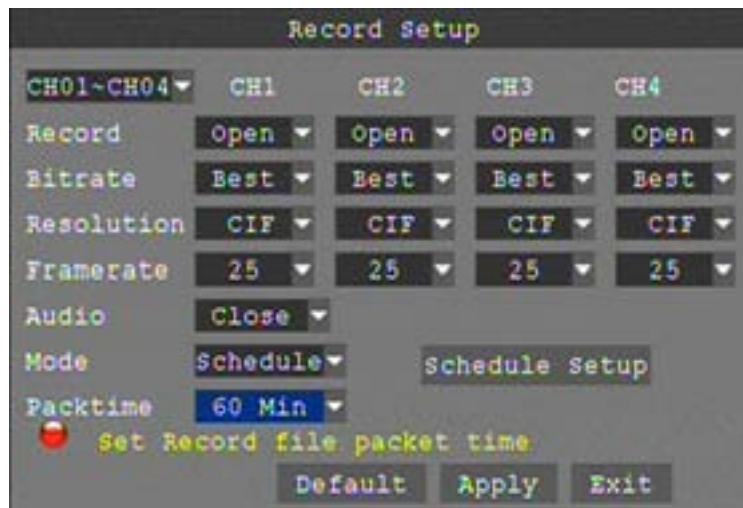

CH01~CH04: You can select the CH01~CH04,CH05~CH08,CH09~CH12(16CH DVR),CH13~CH16(16CH DVR) here.

RECORD: Open: Means the channel enable for recording.

BITRATE: There are three options, corresponding different data stream standard

AUDIO: Open: Means enable the audio recording for all channels, Close: Means disable audio recording

REC.MODE:

Always: Means the device will start recording when it startup.

Schedule: Recording as the schedule, you can setup the schedule as you want as follow.

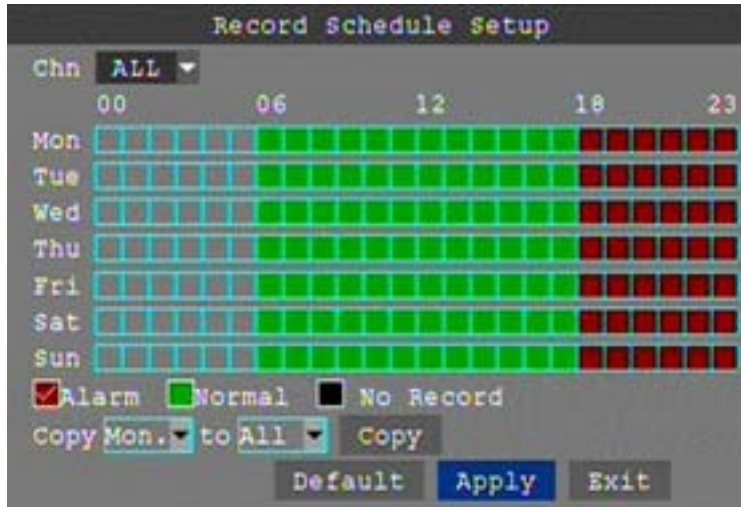

CHANNEL: You can select all channels or just one channel to setup schedule.

WEEKLY: You can setup each as you want. There are ALARM, NORMAL, NO REC three modes, if you select this, there will have a √ in the frame, that means when you select the period of the day it will record as this mode, and you can just setup one day, then copy the setting to all other days. Different color means different record mode: Red means alarm record, green means normal record, grounding means no record.

PACK TIME: There are 15min, 30min, 45min, 60min four options, that means it will pack as the mode you selected

Scroll to **APPLY** and press **ENTER** to save the new settings.

2.2.2.3 NETWORK SETUP

Move the cursor to **【NETWORK】** (Icon with the orange box means that selected), and press **【Enter】** to enter into setting interface .

TYPE: There are PPPOE, DHCP & Static three options.

● STATIC

Select [Static] in the type, and press [Enter] to enter into the interface as followings

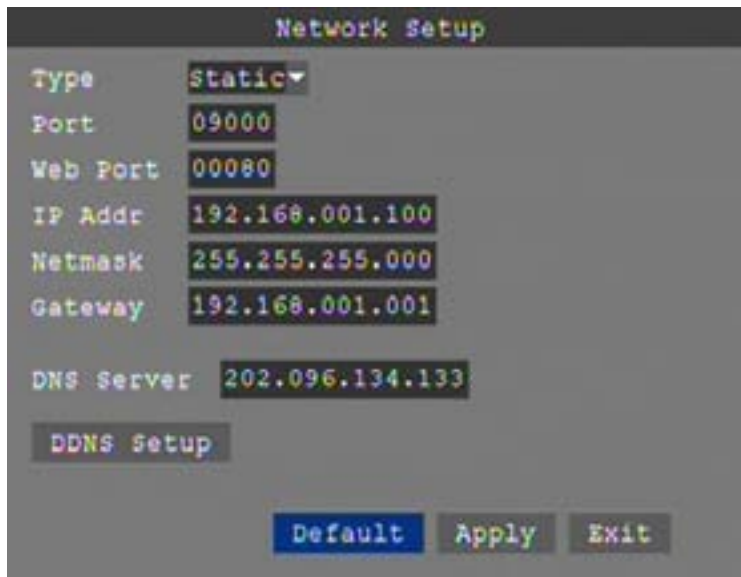

PORT: For video transmission via IE.

WEB PORT: setup the port of IE browser via HTTP.

IP ADDRESS: setup the IP address, and press [Enter] or number keys to change the value.

NETMASK: press [Enter] or number keys to change the value.
GATEWAY: press [Enter] or number keys to change the value.

● **DHCP**

Select the DHCP, and enter into the interface as followings.

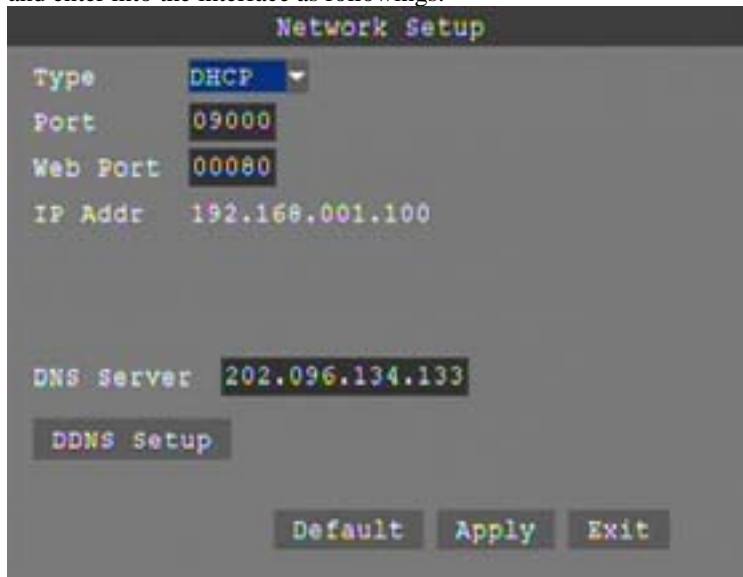

PORT: the communicate port between PC and DVR, recommend use default port.

WEB PORT: setup the port of IE browser via HTTP.

Remark: when you setup the net mode as DHCP, the router will arrange a dynamic IP for DVR.

● **PPPOE**

Select the PPPOE, and enter the interface as followings

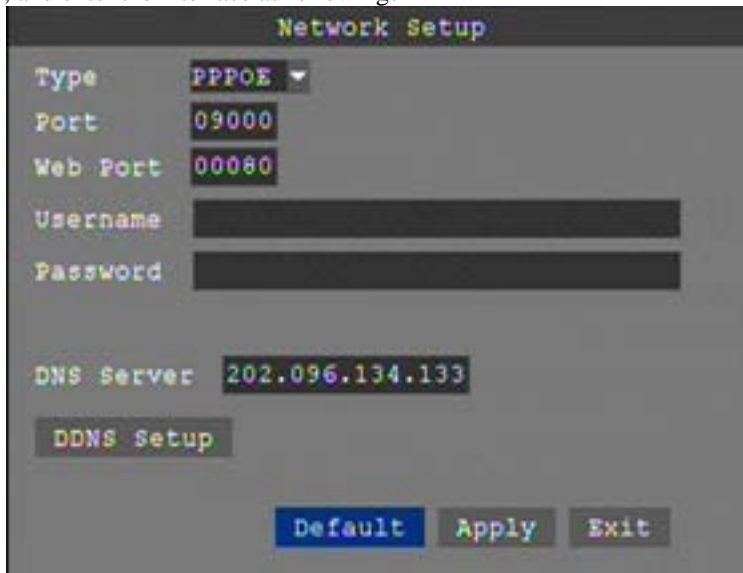

MEDIA PORT: the communicate port between PC and DVR, recommend use default port

WEB PORT: setup the port of IE browser via HTTP.

PPPOE username and password: fill the username and password of the internet service offer, and apply it and reboot the system. After rebooting, the device will save it and set the PPPOE as default network type. If succeed, the IP address will be automatically config as dynamic IP of WAN.

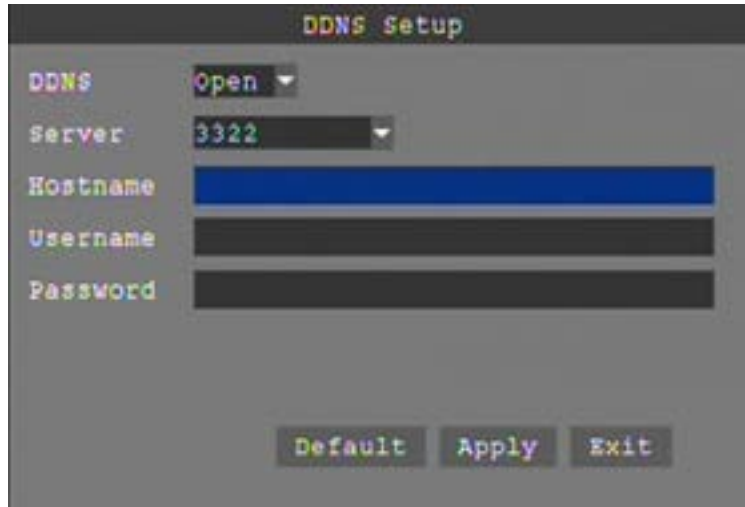

DDNS: There are [Open/Close], and if there is a DDNS service, please setup it as Open.

SERVICE: There are 3 services to select, 3322, dyndns, and perfecteyes.

HOST NAME: Input the name of the host server.

USERNAME: Input in the name of the user.

PASSWORD: Input the password for DDNS.

2.2.2.4 SEARCH

Move the cursor to **【SEARCH】** (Icon with the orange box means that selected) ,press **【Enter】** to enter into the setting interface.

DATE: You can adjust the checking date and time, press **【Enter】** input the number directly to adjust the year,month,date.After finishing the time setting, move the cursor to “SEARCH” and press”APPLY”,can see the recording status of this date. As follow:



Instruction:

1. MONTH: It will show all the recording status in this month. Green means normal recording, Red means alarm recording, Grounding means no recording. Click any date in this frame can search the recording status of that day, the searching result will be showed in the below date frame.

2. DAY: It will show all the recording status in this day, you can playback the record file in this period via click the corresponding period.

PLAY: You can press **【Enter】** input number directly to setup playback time. After setting, move the cursor to “PLAYBACK”, and then press”APPLY”to enter into video playback of that time. Also you can select any period of time in the video status frame after searching,press”APPLY”to enter into the video playback of this period.

DETAIL FILES: Enter into the video file list interface of the selected date.
LOG SEARCH: Enter into the log searching interface.

2.2.2.5 DETAIL FILES

Setup the searching date, after pressing “SEARCH”,move the cursor to “Detail files” and press”APPLY”to enter into the video file list of this date.

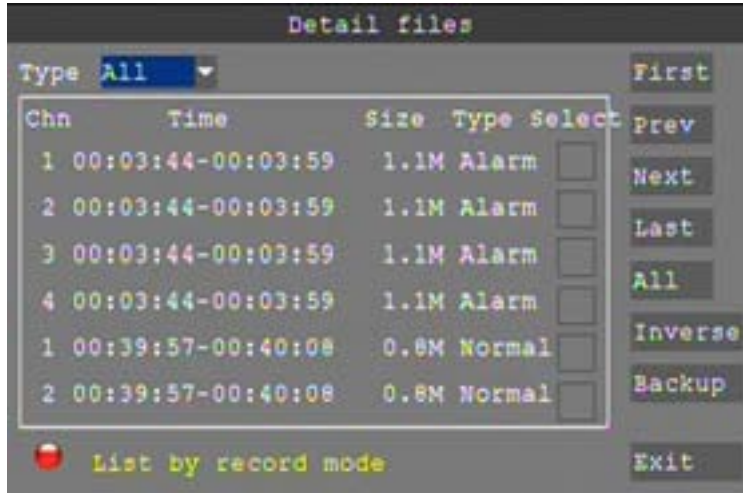

Then you can select four channels as you want to playback, because 8CH DVR support 8channels playback at the same time. By the way 16CH DVR support 16 channels playback at the same time.

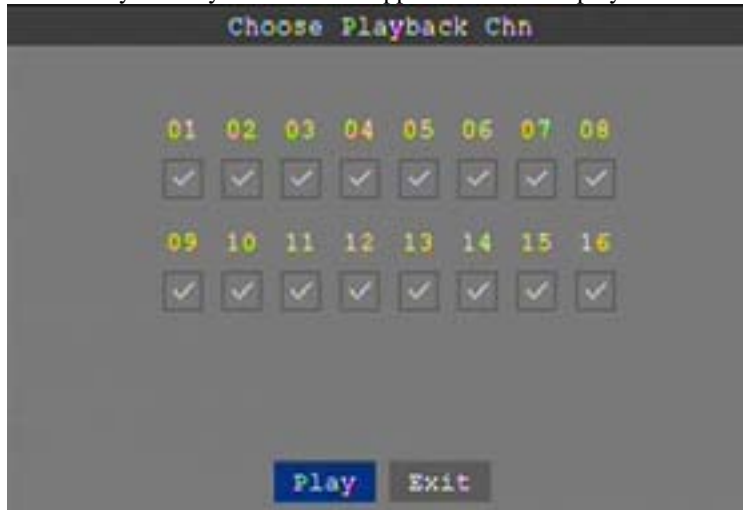

Instruction:

- 1. 【DETAIL FILES】**,”CHANNEL”is the recording file which belong to which channel, “SIZE” is display the size of this file (Unit:MB) , “TYPE” is display the type of recording file, there are two types: normal and alarm,press“BACKUP”button can export the selected files to USB storage;
- 2.** After moving the cursor up and down and select the files, and press【APPLY】to enter into playback interface. If the all channels have recording files, it will be playback all windows at the same time.
- 3.** If setup as “Open” in the 【RECORD TIME】 in 【DISPLAY】 , it will show the date/time when playback record file; If setup as “Close”it will not display time.
- 4.** When playback, can press 【>>>】 to play slowly; press 【>>>】 and 【<<<】 to speed、 reverse play; also can press【>>>】to pause and frame by frame play; Press【Exit】to exit from playback and return to the former menu;
- 5.** When finished playback files, it will return to the file list interface.

2.2.2.6 BACKUP

You can use USB for backup, should insert USB device into the USB2.0 port before backup files. And it is support USB OTG.

You can select the recording file by direction keys, and press **【Enter】** means selected OK (There is a “√” at the end of the selected recording files) and press **【Enter】** again the “√” will disappear that means cancel the select, we can start export the recording files after selecting, and press **【BACKUP】** to start to backup, as follow:

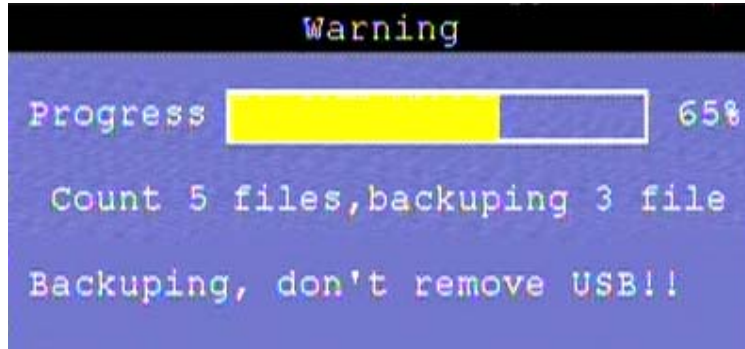

Instruction:

1. When the space in backup device less than recording file, the system will prompt “Space no enough”.
2. You can move USB device directly when backup finished.

2.2.2.7 LOG SEARCH

Move the cursor to “LOG SEARCH” and press “APPLY” to enter into the log file list of DVR, as follow window.



INFO: means the alarm type.

TRIGGER: means the alarm triggered time.

VIDEO: means whether the log has corresponding video file.

2.2.3 DEVICES SETUP

Move the cursor to **【DEVICES】** (Icon with the orange box means that selected), press **【Enter】** to enter into setting interface.



Advanced Features include HDD, ALARM, PTZ, MOBILE and MOTION DETECT.

2.2.3.1 HDD MANAGE

Move the cursor to **【HDD】** (Icon with the orange box means that selected) ,press **【Enter】** to enter into the setting interface, and you can use direction keys and cursor to change the options.

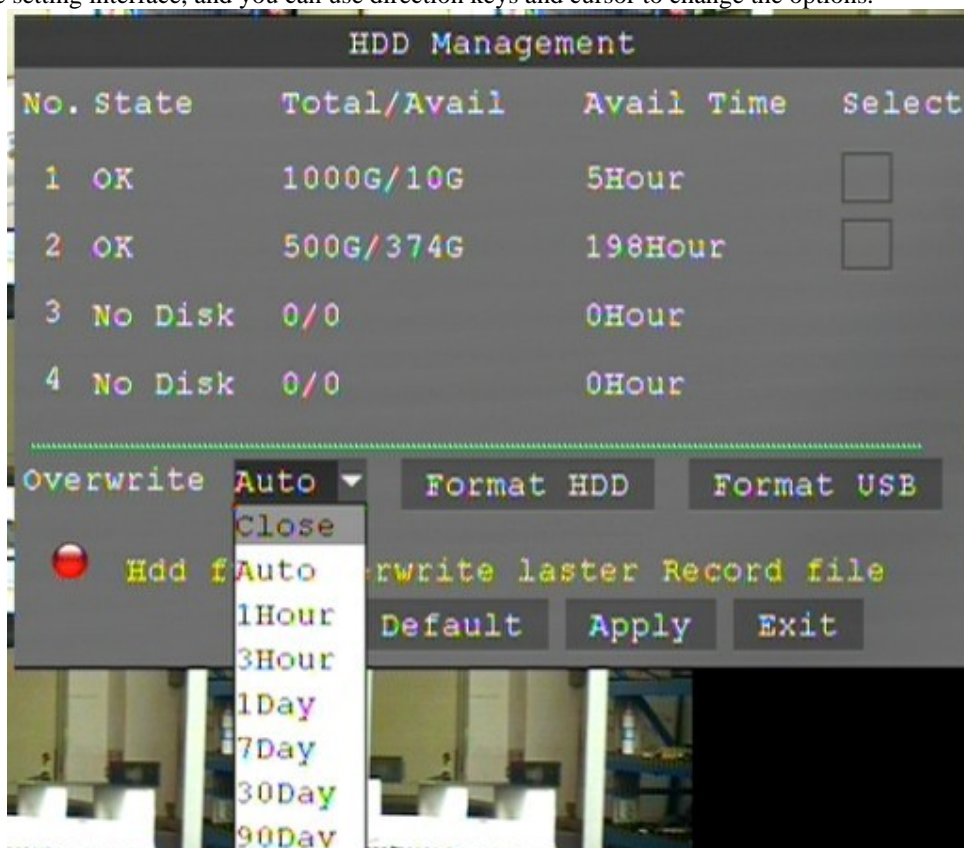

HDD STATUS: There status is ok means the HDD is ok. If HDD can not run normally (including unformat and no HDD) , there is a **【H】** display on video live view, 8CH DVR can support 1HDD at most.so you can select the HDD you want to format here.

OVERWRITE:Auto: means when HDD space less than 4G, it will delete HDD earliest recording file, and it will stop deleting when the space is 10G; DISABLE: means when HDD space less than 500M it will stop recording, and an prompt will display in live view “please shutdown and replace HDD”
1H 3H 1day 7day 30day 90day is reserved 1H 3H 1day 7day 30day 90day recording for this time

HDD FORMAT: Move cursor there to select device and press **【APPLY】** to start formatting.
U DISK FORMAT: format the external thumble drive.

2.2.3.2 ALARM SETUP

Move the cursor to **【ALARM】** (Icon with the orange box means that selected), press **【Enter】** to enter into setting interface.

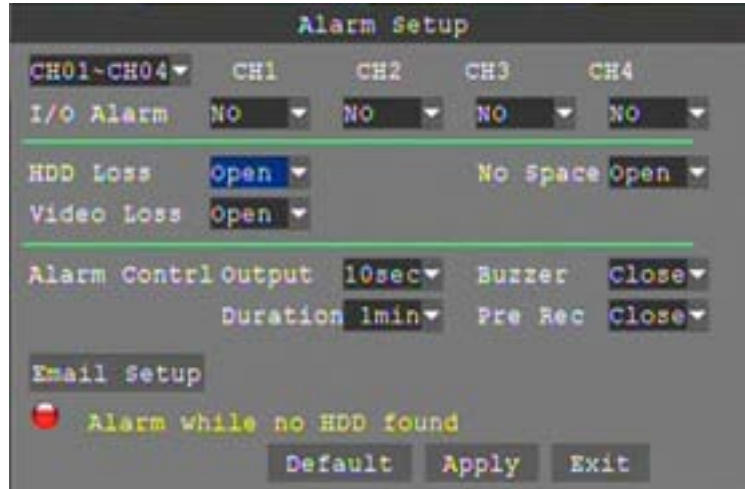

CH01~CH04: you can select the CH01~CH04,CH05~CH08,CH09~CH12(16CH DVR),CH13~CH16 (16CH DVR)here.

I/O ALARM: Each channel has an I/O status, that is, when an alarm triggered, it will activate the corresponding channel to start alarm recording.

N.O: indicate I / O input level from high to low effective

N.C: indicate I / O input level from low to high effective

HDD LOSS:Open means it will trigger a alarm if there is no HDD, and it will display an **【H】**

On the bottom left of channel 1 in the live view

HDD SPACE: Open: If the space less than 500M, there is a remark in live view: No enough space, please change HDD after shutdown.

VIDEO LOSS: Open: when one channel has no video input, it will display “video loss”in live view.

ALARM CONTRL: There are alarm output, buzzer Durationand pre Rec four items.

- **OUTPUT:** when an alarm triggered, the alarm output time will be:
0 second、 10 seconds,20 seconds,40 seconds and 60 seconds
- **BUZZER:** buzzer calling time setup when alarm triggered: close,10 seconds,20 seconds,40 seconds and 60 seconds
- **DURATION.:**post recording time setup: 30 seconds,1 minute,2 minutes and 5 minutes
- **PRE REC:**Close/Open

Email setup

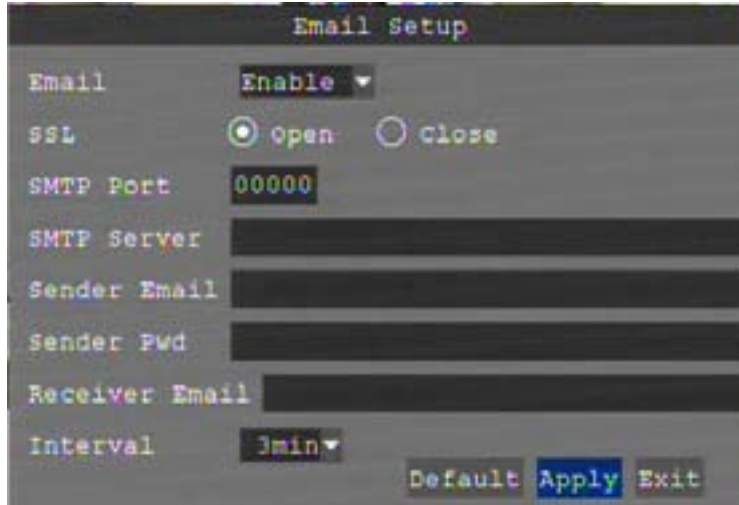

Functions		
Email	Enable: Open	Disable: Close
SSL	Enable: Open	Disable: Close
SSL is a security link transport protocol. You can encrypt your communication info (including your email) using SSL to prevent hackers from monitoring your email or communication info and even your password. Please confirm with your email service provider if your email server support SSL or not.		
SMTP Port	The Specified sender port of SMTP server(forwarding server/Host)	
Generally the SMTP port value is 25 ,but for SMTP port of G-mail server is 465. *if your E-mail needs to be verified by SSL, the port is going to be 465(default value), and port 25(default value) is the Email without SSL verification.		
SMTP server	Simple Mail Transfer Protocol (SMTP) is an Internet standard for electronic mail(e-mail) transmission across Internet Protocol (IP) networks.	
Sender Email	The original sender (forwarding server/Host).	
Sender PWD	Password of original sender	
Receiver Email	The target receiver of alarm notification (target).	

2.2.3.3 PTZ SETUP

Move the cursor to **PTZ** (Icon with the orange box means that selected), press **Enter** to enter into setting interface, you can setup the parameters for each channel separately.

CH01~CH04: you can select the CH01~CH04, CH05~CH08, CH09~CH12 (16CH DVR), CH13~CH16 (16CH DVR) here.

PROTOCOL: select the protocol of different PTZ, there are two protocols to switch, and the default is Pelco-D

BAUD RATE: select the different baud rate for your PTZ, there are 1200, 2400, 4800, and 9600

DATA BIT: there are 5,6,7,8 options to select, default setting is 8.

STOP BIT: there are 1 and 2 to select, the default setting is 1.

PARITY: there are None/Odd/Even/Mark/Space to select, the default setting is none.





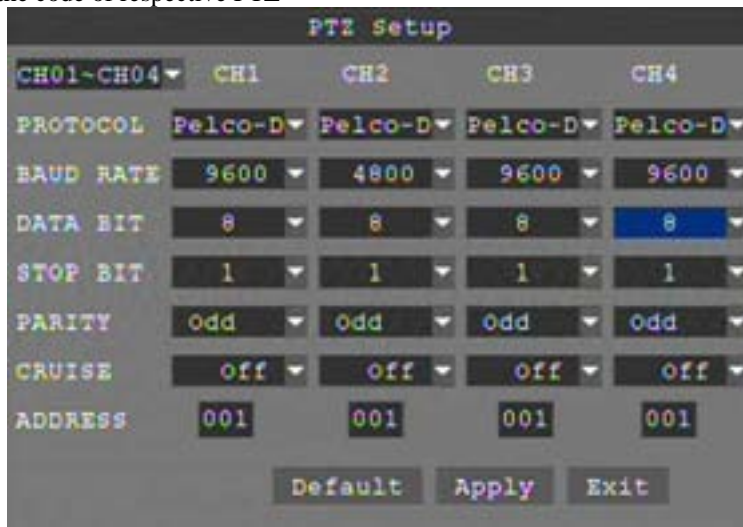

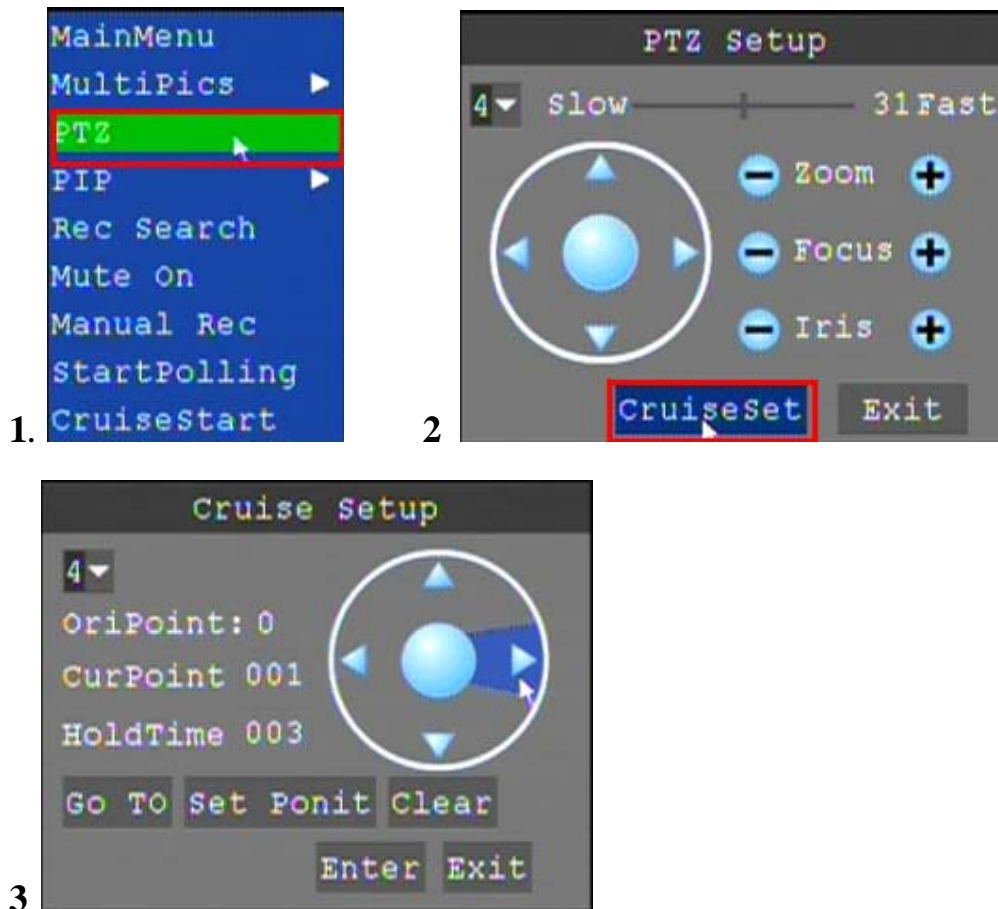

CRUISE: ON means the corresponding all channel's open auto cruise function, OFF is not open

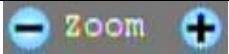
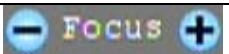
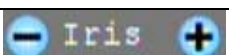
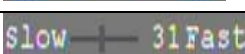
ADDRESS: Fill the code of respective PTZ

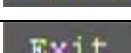

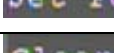
PTZ Control

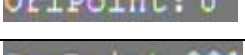

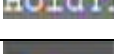
All Functions		
	Pointer Auto Pan	To select the direction of PTZ The middle circle is for auto pan of PTZ.
	Zoom in/zoom out	
	Focus	
	Iris	
	Volume	PTZ control the speed
	Channel select	For selecting the channels of PTZ camera.
	CruiseSet	To cruise setup
	Exit	To back to previous page or exit
	Go to preset point	Allow you to go to a specific preset point.
	Set Point	Allow you set a set of specific preset points of a PTZ camera. Also it can Adjust the camera in a fix point.
	Clear	Allow you to delete the selected preset
	Oripoint	Set up pre-set bit quantity
	Curpoint	It indicates the starting point cruised. System default point is 01.
	Holdtime	Sets the stop time at each point
	Save	Save the changed and the preset point.

Cruise(PTZ)

This function allows to start cruise of PTZ camera. (According to the preset set to automatic cruise)

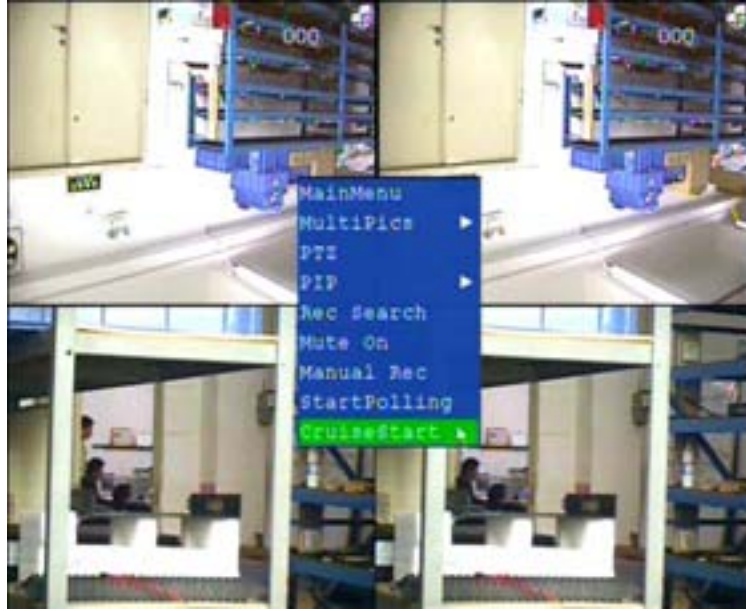

2.2.3.4 MOBILE

Move the cursor to **MOBLE** (Icon with the orange box means that selected), press **Enter** to enter into setting interface.

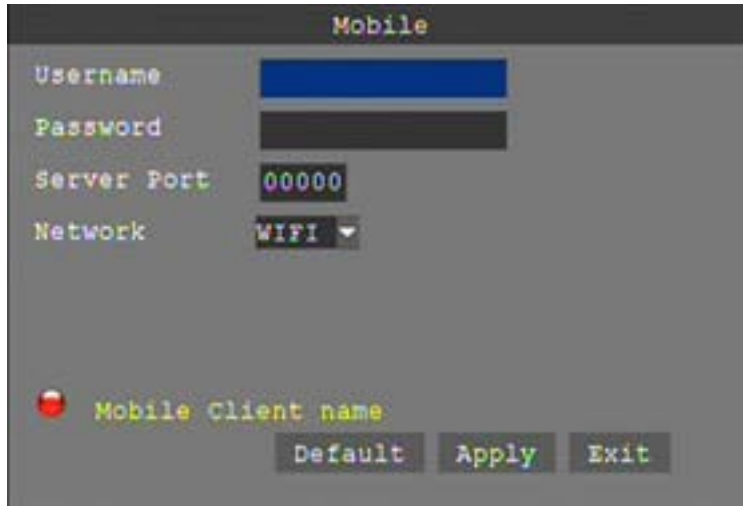

USER NAME:The login user name of DVR

PASSWORD:The login Password of DVR

PORT: the port for mobile view, you should open the port in the router for mobile view. Please note that the server port of DVR must with the same port of mobile .

MOBLESS LAN: Select different mobile network from the options of WIFI, 2.5G, 2.7G,3G and WIFI, and press [Enter] to switch different network.

2.2.3.5 MOTION DETECT

Move the cursor to **MOTION** (Icon with the orange box means that selected), press **Enter** to enter into setting interface.

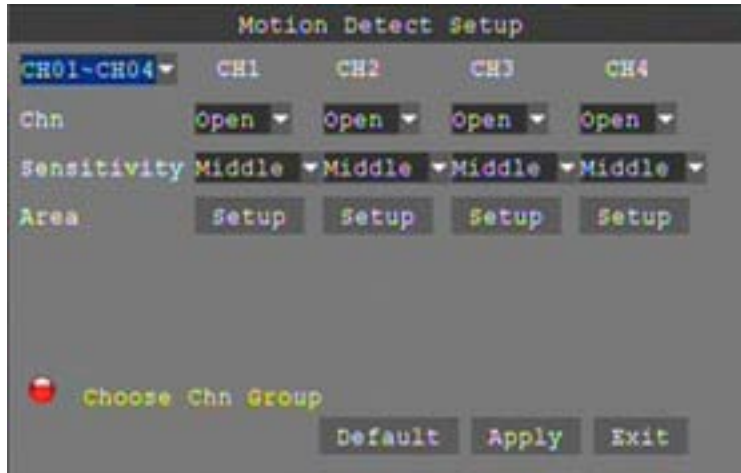

CH01~CH04: you can select the CH01~CH04,CH05~CH08,CH09~CH12(16CH DVR),CH13~CH16(16CH DVR) here.

STATUS: Each channel has corresponding channel switch, press **【Enter】** to turn on or turn off the motion detection for each channel..

SENSITIVITY:Each channel has corresponding sensitivity setting, including four standards highest,high,middle and low, press **【Enter】** key to switch

MD AREA: each channel has corresponding regional motion detecting setting, move the cursor to corresponding **【setting】**,press **【Enter】** to enter regional setting interface, red area means it have activated motion detection, transparent block means it have not activated motion detection.

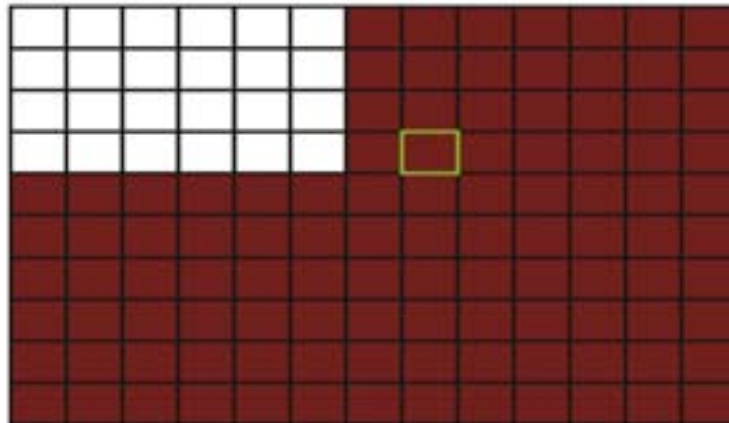

Move the direction key on remote control to make cursor move in the small pane, green frame means the cursor has moved to this pane, press **【Enter】** to select or cancel motion detection of this small pane, when setup finished, press **【exit】** to back to MD setup interface, it will save automatically.

Remark:

IR Operation: press [Menu] key to select or cancel the entire screen.

Mouse operation: click left and drag the frame to setup the region for motion detection.

2.2.3.6 EXIT

Move the cursor to **【EXIT】** (Icon with the orange box means that selected) ,press **【Enter】** to back to main menu.

2.2.4 SYSTEM SETUP

Move cursor to select**【SYSTEM】** (Icon with the orange box means that selected)and press**【ENTER】** to enter into the system language setup interface.



System setups include time/date, password, video/audio, language, info and maintain six options.

2.2.4.1 DATE/TIME SETUP

Move cursor to select **【TIMEDATE】** (Icon with the orange box means that selected) and press **【ENTER】** to enter into the date/time setup interface.

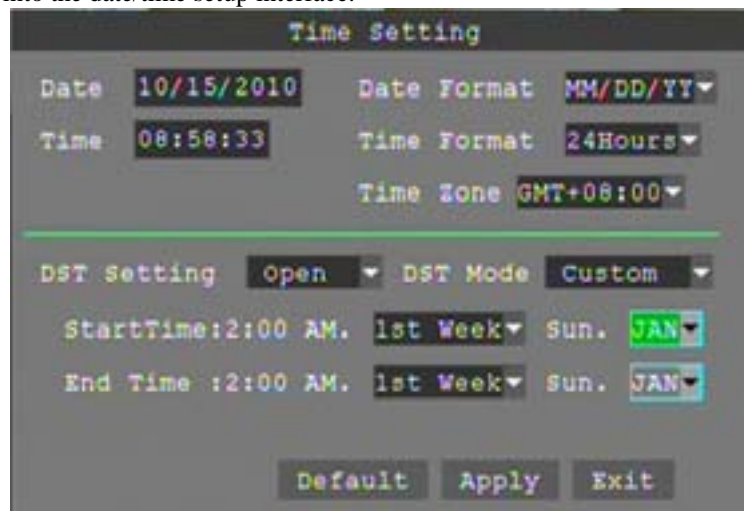

DATE: Setup system date via numeric key.

DATE FORMAT: Press ENTER to switch between the date patterns, there are YY-MM-DD and MM/DD/YY two options.

TIME: Setup system time via numeric key.

TIME FORMAT: Press ENTER to switch between the date patterns, there are 12 HOURS and 24 HOURS two options.

Remark: You must press **【APPLY】** to save it, otherwise it won't save the modify if you exit this interface.

DST: DST settings, you can setup DST as you want here.

2.2.4.2 PASSWORD

Move the cursor to **【PASSWORD】** (Icon with the orange box means that selected), press **【Enter】** to enter into the setting interface.



DEVICE ID: Press number key to setup the unite ID

PASSWORD: Press **【APPLY】** to open or close user password. If it is “OPEN”, you must input password when log in, otherwise, you can enter into main Manu directly.

USER PASSWORD: Press number keys to setup user password.

ADMIN PASSWORD: Press press number keys to setup admin password.

2.2.4.3 VIDEO/AUDIO SETUP

Move the cursor to **【A/V SETUP】** (Icon with the orange box means that selected) ,press **【Enter】** to enter into setting interface.



NORM: press **【Enter】** to switch camera system, has PAL and NTSC two options

POLL TIME: the interval for channel loop function

SEQUENCE: you can setup the channel sequence as you want here.

VGA RESOLUTION: press **【 Enter 】** key to setup the VGA resolution, there are 1024*768,1280*1024,1920*1080,1440*900 four options.

VOLUME: move cursor to **【VOLUME SETUP】** ,press **【Enter】** to enter into volume setup interface, press number keys or directly drag the cursor to adjust volume.

Remark: it will restart if you modify the Norm(video system) or VGA resolution.

2.2.4.4 LANGUAGE

Move cursor to select **【LANGUAGE】** (Icon with the orange box means that selected)and press **【ENTER】** to enter into the system language setup interface.

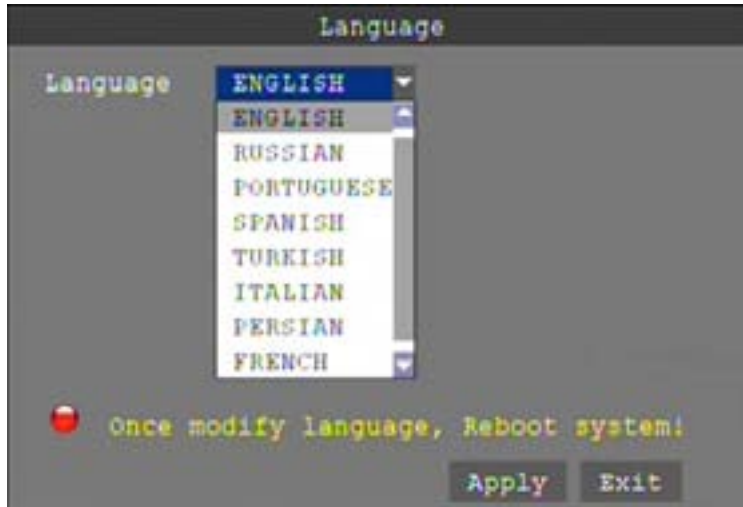

System language have Chinese and English two options, you can setup the language you want in here.

Remark: The device will restart when you setup system language success.

2.2.4.5 SYSTEM INFO

Move the cursor to **【INFOMATION】** (Icon with the orange box means that selected), press **【Enter】** to enter into setting interface, at this interface mainly display system hardware features and firmware version, include : Device ID, Software Ver and MAC Address.

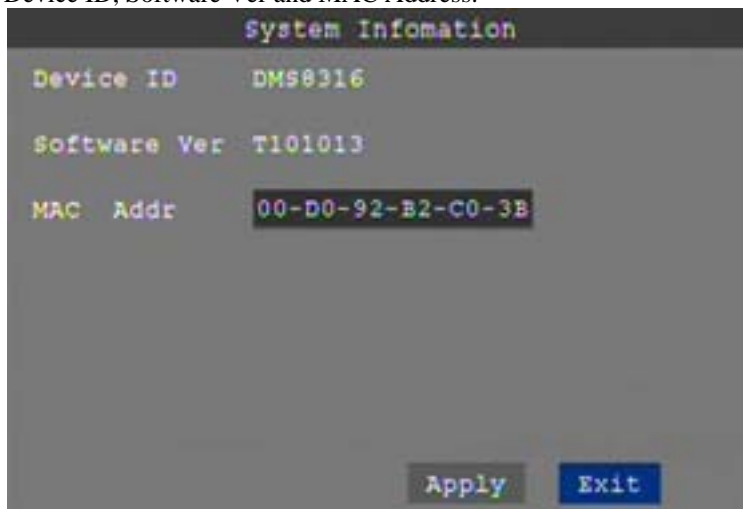

2.2.4.6 SYSTEM MAINTAIN

Move the cursor to **【MAINTAIN】** (Icon with the orange box means that selected), and press **【Enter】** to enter into system maintain setup interface.

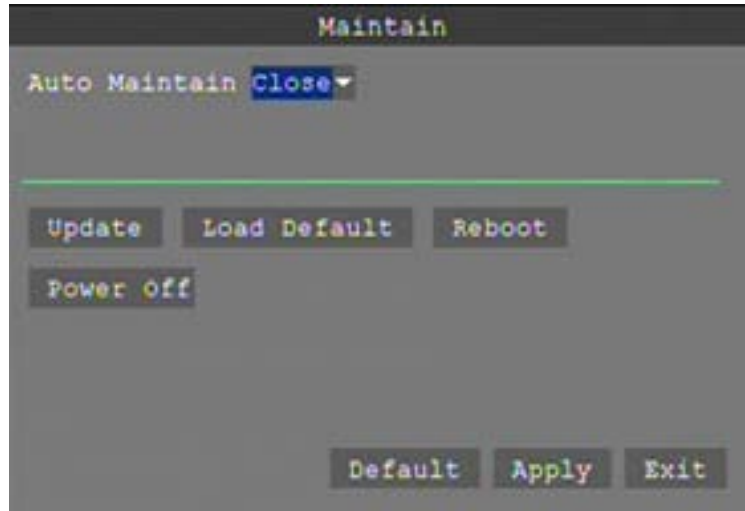

AUTO MAINTAIN: When switch is on, you can setup the time for device to restart.

SYSTEM UPDATE: Copy the update file to the “dvrupgrade” folder in the root directory of the thumb driver, and insert it into USB 2.0, then press [Enter] to upgrade the firmware, and it will display the process of the system upgrading, as following.

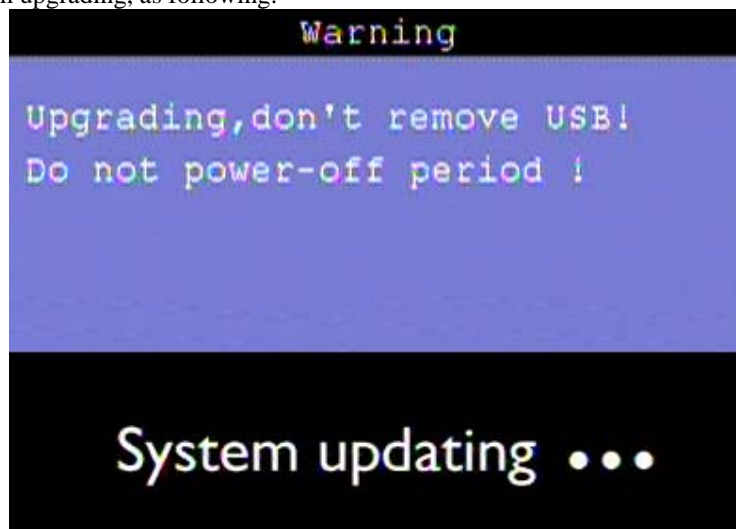

REBOOT: means restart the device.

POWER OFF: The button allows to shut down the system from OSD.

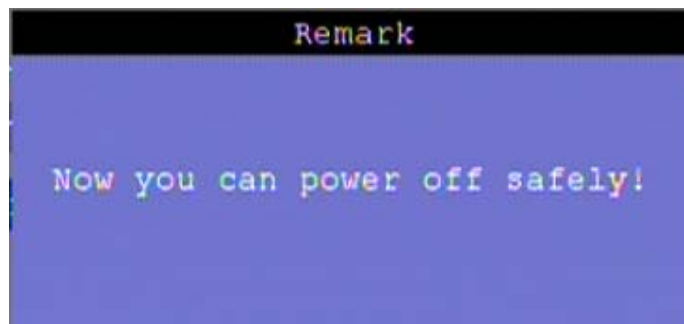

3 IE OPERATION

3.1 FEATURE

Through the IE browser of OS and install the software, you are able to do the network operation remotely, which is much more convenient. DVR support C/S, B/S, and visit in LAN and WAN, also support IP and domain name visiting.

Remark: Operating system Windows XP, Windows Vista and Browser IE6.0, IE7.0 is recommended

3.2 USER LOGIN

Input the DVR local IP in IE browser, when changed the port, you should add the port number after IP address, e.g. if DVR local IP is 192.168.1.118 (LAN) and the port is 8088, you should input 1http:// 192.168.1.118:8088. The default port is 8088, and directly input http:// 192.168.1.118 to access the login interface as following.

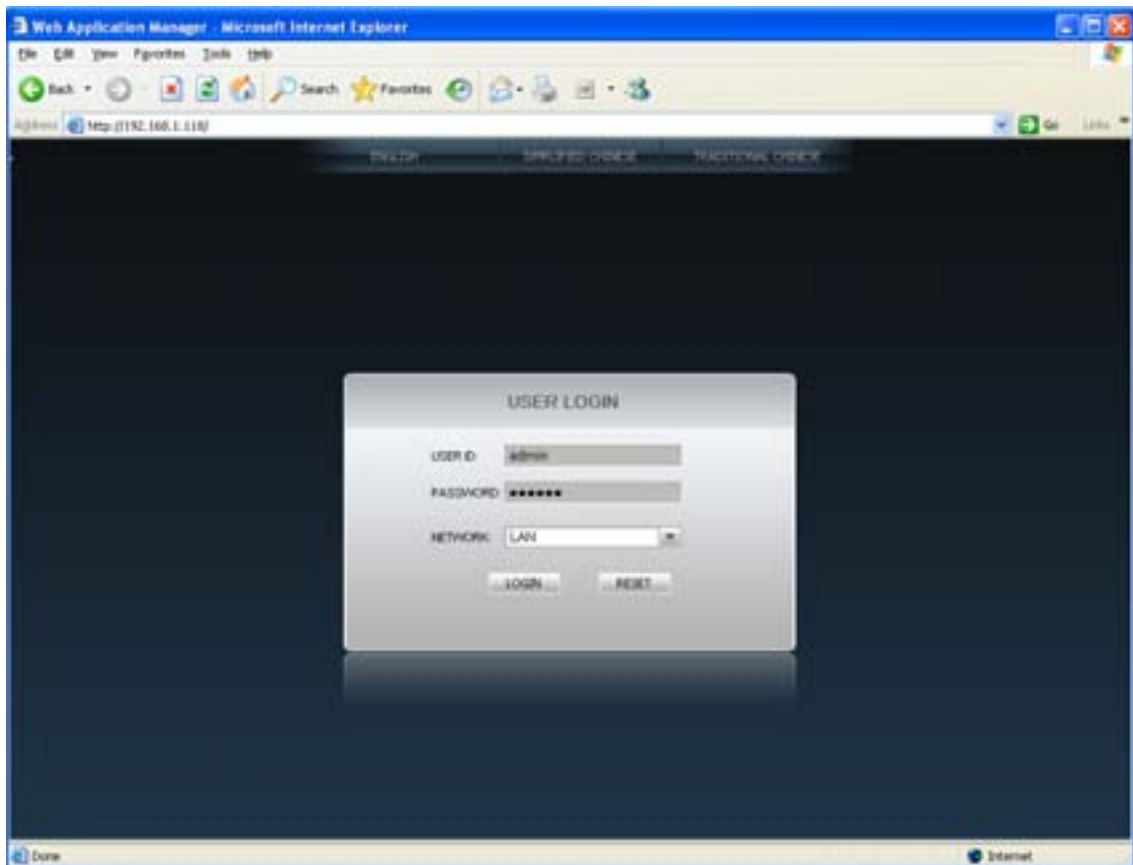

Select English interface in the top left side. Input username and password to enter into the system. The username and passport is same as the ones set in DVR, Sign in IE must enter a user name and password to log in, the user name and password consistent with the DVR, the default administrator user: admin, the corresponding password is: 123456,

PASSWORD: Administrator has all authorities, operator has limited authorities who they can only watch, playback, please change the unit No. and default password is blank.

NETWORK: LAN/INTERNET(WAN)

Remark: If you connect the device in WAN, the IP should be a public IP.

3.3 OPERATION INTERFACE

There are Live view, Playback and Setup options in the main interface, please press them to access it.

3.3.1 LIVE

Click  to enter into the interface as followings

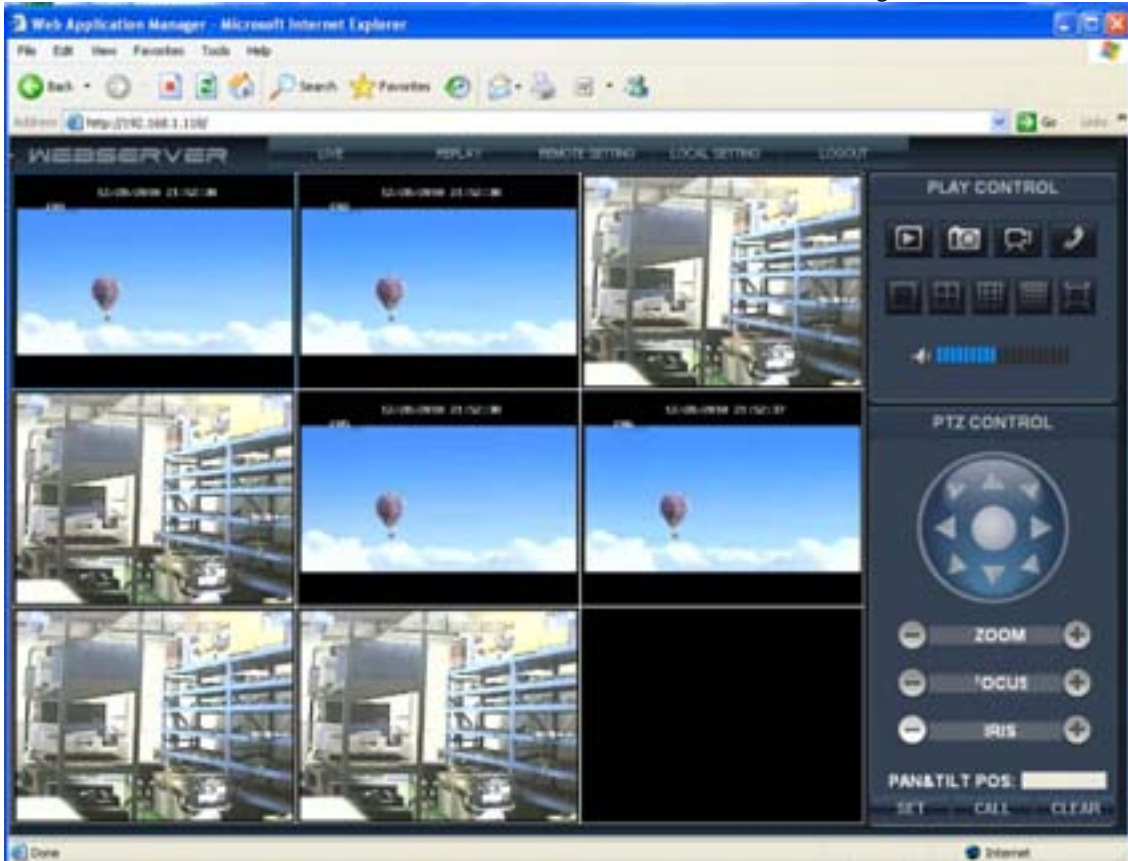

3.3.1.1 PTZ CONTROL

Change the focus, preset aperture to control the PTZ.



Click  to up/down/left/right control movement of the PTZ. When hold on the one direction key, the PTZ will keep circling as that direction after user press the stop key in the center of the wheel.

3.3.1.1.1 ZOOM

Click  to zoom in and out.

Click  to focus

Click  to change the size of aperture

3.3.1.1.2 PTZ PRESET

 Setup preset point.

You can control it via the below three buttons: 

3.3.1.2 PLAY

Move cursor to the icons, it will highlighted when selected





Open all windows.



Capture picture, save in local disk, the default save path is C:/DVR



Quickly start all channels' recording video, here the left up corner of each channel have

normal recording video symbol **【R】**, click icon to switch between single screen /quad /nine



/16 split



/ full screen



 Volume adjust button

3.3.1.3 OTHER OPERATION

1. Select one channel at preview screen (the selected channel's frame will be change to RED), double click left key, enter to the selected channel single screen display.
2. Click one Chanel via left key at preview screen, then click right key, will occur window shortcut Menu, see below picture

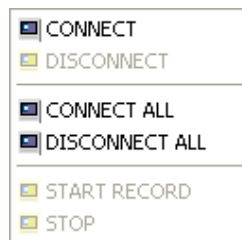

You can open, shut down and start this channel's record via shortcut menu.

3. Click right key at one live view screen, click "open all windows" or "close all windows", will quickly open/close all windows.

3.3.2 REPALY(IE Browser)

Step 1. Click "Replay" option.

Step 2. Click the date which you would like to playback.

Step 3. Also, you can click  button to search the video file again, or use file list to

choose which channel you would like to playback, and then click on " **SEARCH** " button.

*The video file list will be displayed.

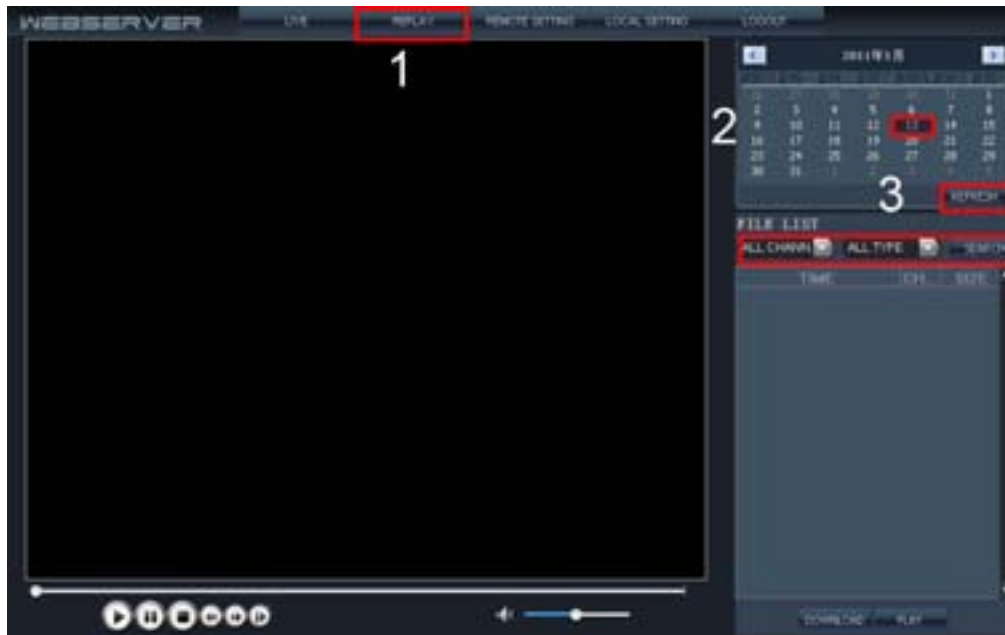

Step 4. Click specified video file which you would like to playback, remotely.

The video will be displayed. When the video file is playing, the system won't allow you to download video files.

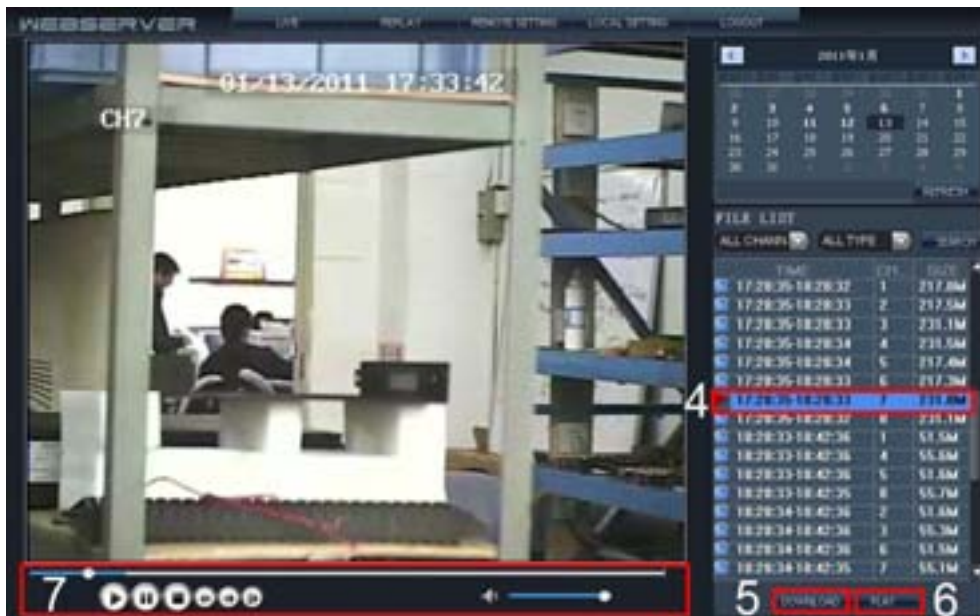

Step 5. Close the playing video and then click **DOWNLOAD** button to download video file.







Step 6. When the video file was downloaded, the dialogue box will display.



Step 7. Playback control



The above purple progress bar shows download progress, green progress bar shows playback progress

-  Switch between pause/play
-  Pause
-  Stop play
-  Fast play
-  Slow play
-  Pause at next frame

3.3.3 REMOTE SETTING

Click **REMOTE SETTING** to enter into setup interface, this interface include Encode setting, Record setting, Alarm setting, PTZ setting, Network setting, Advanced setting and system information seven menus.

3.3.3.1 ENCODE SETTING

Click **ENCODE SETTING** to enter into setup interface; you can check the parameter settings as in GUI of DVR.

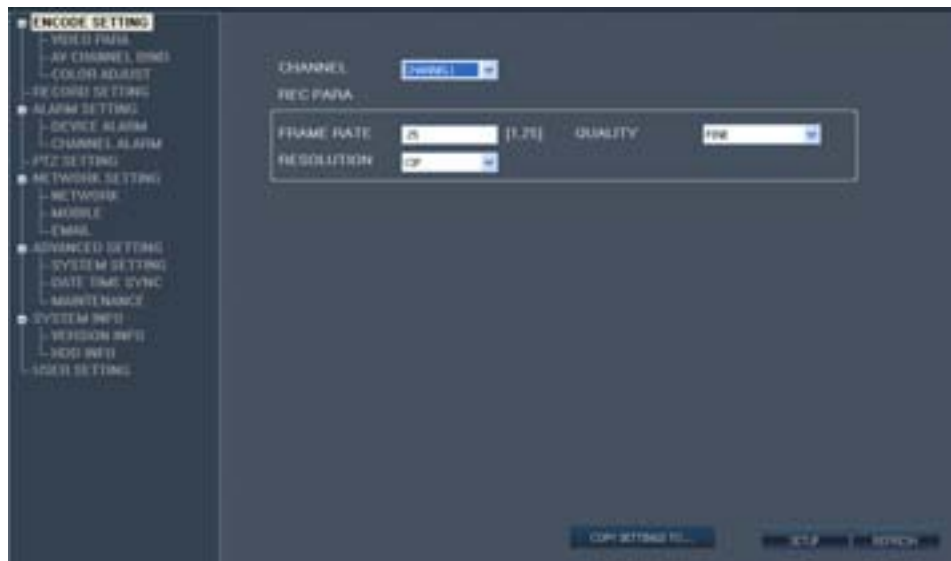

Click **AV CHANNEL BIND** to enter into setup interface; you can check the parameter settings as in GUI of DVR.

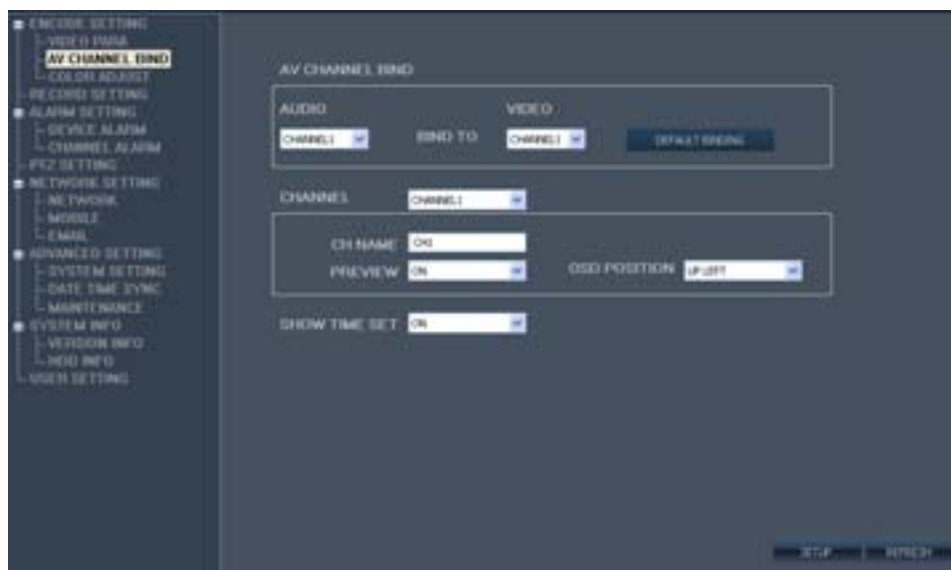

Click **COLOR ADJUST** to enter into setup interface; you can check the parameter settings as in GUI of DVR.



when you see " **COPY SETTINGS TO...** "button, you can copy the setting to the channel which you would like to copy.

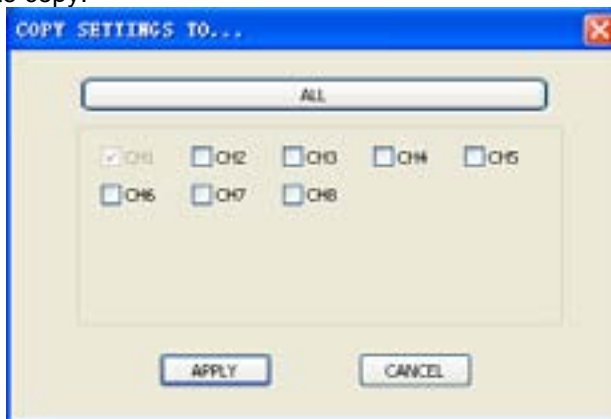

3.3.3.2 RECORD SETTING

Click **RECORD SETTING** to enter into setup interface; you can check the parameter settings as in GUI of DVR.



3.3.3.3 ALARM

Click **ALARM SETTING** and **DEVICE ALARM** to enter into setup interface; you can check the parameter settings as in GUI of DVR.



Click **CHANNEL ALARM** to enter into setup interface; you can check the parameter settings as in GUI of DVR.



3.3.3.4 PTZ

Click **PTZ SETTING** to enter into setup interface; you can check the parameter settings as in GUI of DVR.



3.3.3.5 NETWORK

Click **NETWORK SETTING** to enter into setup interface; you can check the parameter settings as in GUI of DVR.



Click **MOBILE** to enter into setup interface; you can check the parameter settings as in GUI of DVR

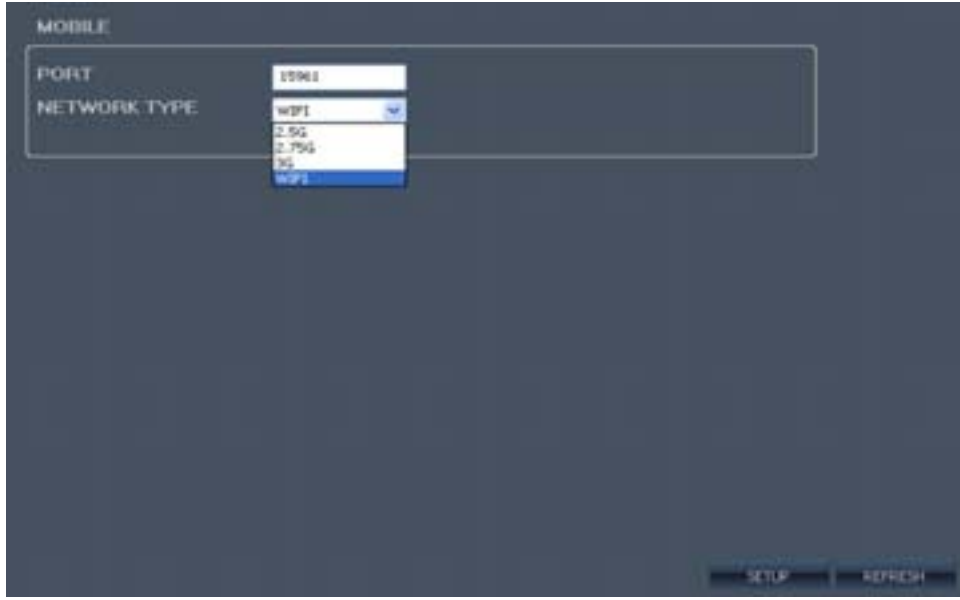

Click **EMAIL** to enter into setup interface; you can check the parameter settings as in GUI of DVR



3.3.3.6 ADVANCED SETTING

Click **ADVANCED SETTING** and **SYSTEM SETTING** to enter into setup interface; you can check the parameter settings as in GUI of DVR.



Click **ADVANCED SETTING** and **DATE TIME SYNC** to enter into setup interface; you can check the parameter settings as in GUI of DVR.

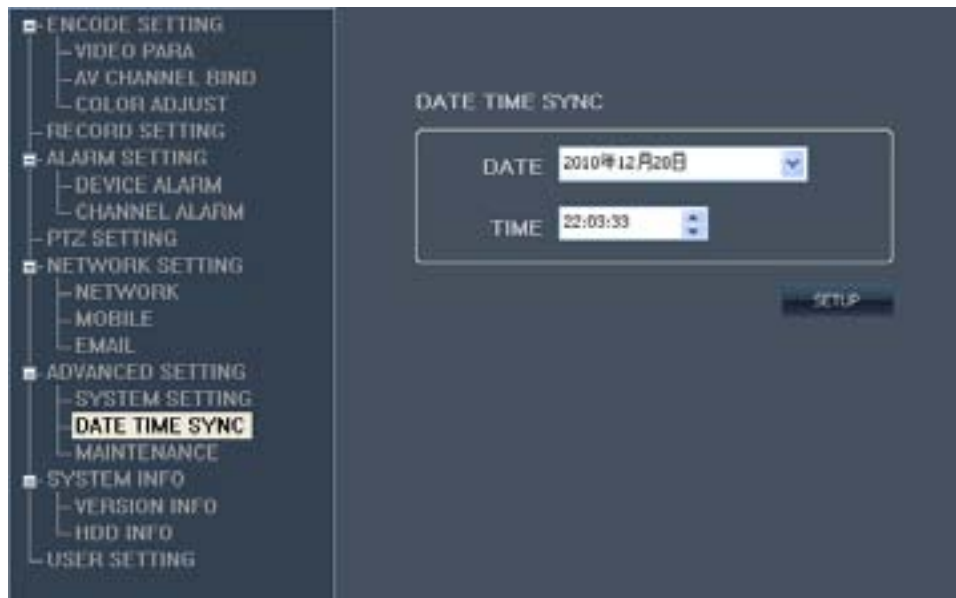

Click **MAINTENANCE** to enter into system information interface; you can check the parameter settings as in GUI of DVR.

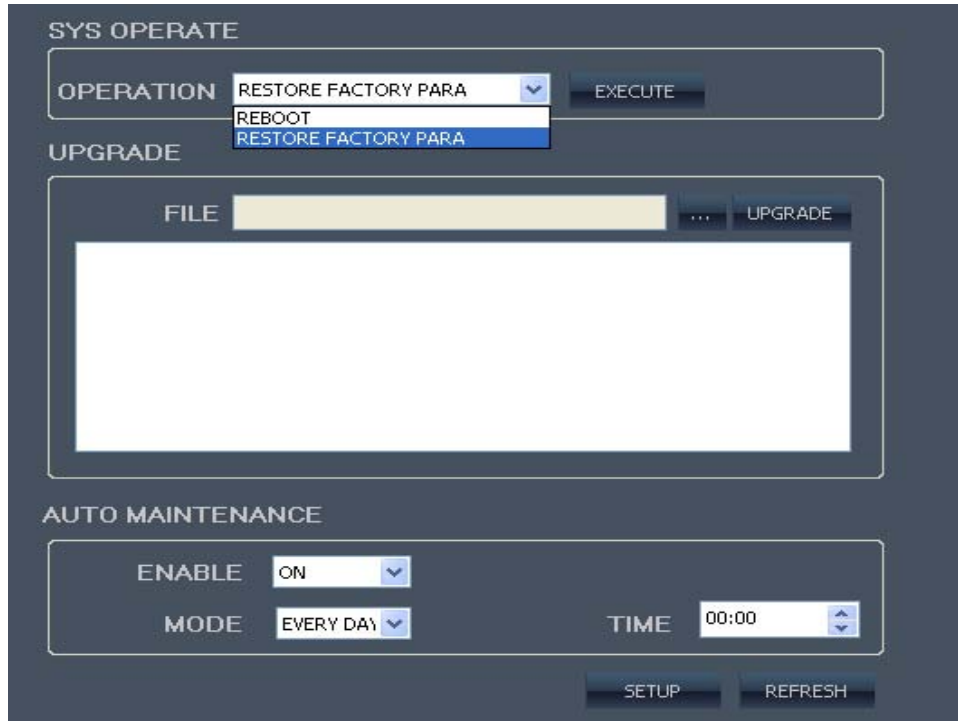

3.3.3.7 SYSTEM INFO

Click **SYSTEM INFO** to enter into system information interface (see below picture), this interface shows HDD status, remain record time, firmware version, and all the information is fixed.



Click **HDD INFO** to enter into setup interface; you can check the parameter settings as in GUI of DVR



3.3.3.8 USER SETTING

Click **USER SETTING** to enter into system information interface, Only the administrator "admin" users can log in to add (to add up to four ordinary users), and only administrators can modify the normal user name and password corresponding to the ordinary user, each user name must be the corresponding password to log in and the corresponding operating authority, the default administrator user name: admin , password is 123456



New logged-in users (up to 5 users)
 Step 1. Select New User or modify the user name and password



- Step 2. Enable: ON
- Step 3. Enter the new user name (user name can not be consistent with existing)
- Step 4. Enter your password (must be 6 digits)
- Step 5: Set the appropriate permissions, PTZ CONTROL: can control the PTZ; PARA SET: you can modify the parameters of the remote control; Upgrade format: there are upgrade and format the hard disk access.
- Step 5: Chik "SETUP" button to add the user save



3.3.4 LOCAL SETTING

Click **LOCAL SETTING** to enter into setup interface; you can check the parameter settings as in GUI of DVR

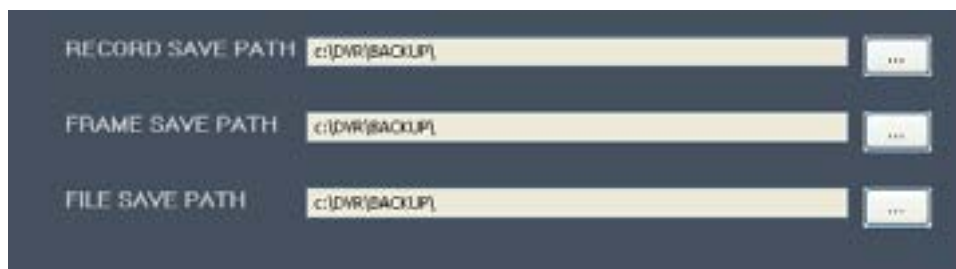

FILE SAVE PATH: capture picture and recording video save path

3.3.5 LOGOUT

Click **LOGOUT** Switch to login screen.

4 DVR INSTALLATION

4.1 PRODUCT OVERVIEW

4.1.1 The Definition of Buttons and Connectors on Front Panel

07 aprear(adapt with 4 channels device and 8 channels device)





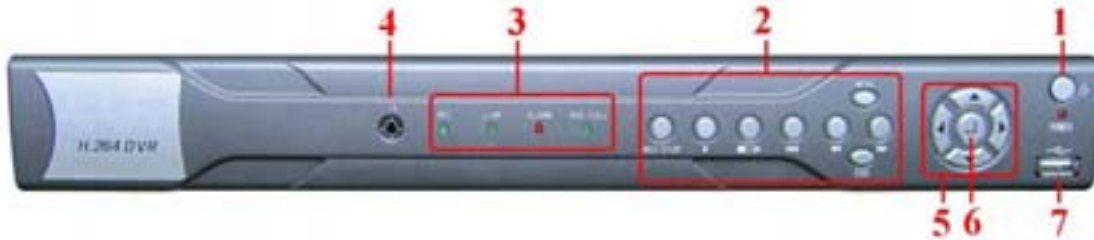

15 aprear (adapt with 16 channels device)



Buttons on Front Panel

NO.	TYPE	NAME	Instruction
1	Power	POWER	Shutdown system
2	Function keys Menu	REC/STOP	Recording control buttons
		◀◀ ▶▶	Fast forward/backward playback
		LOAD	Users Logout
		▶	Playback/play
		■/▶	Playback/play by frame
		ESC	Exit
		▶▶	Slowly playback
		PTZ	PTZ Controler
3	Status indicator	POWER	Power
		REC	Recording

		LINK	On means network has connected
4	IR receiver	IR	Remote control receiver
5	Control button	Direction key	direction key include: up  、down  、left  、right  four buttons.
6	OK	Confirm operation	Enter

4.1.2 The definition of buttons and connectors on fear panel

07 aprear(adapt with 4 channels device and 8 channels device)



15 aprear (adapt with 16 channels device)

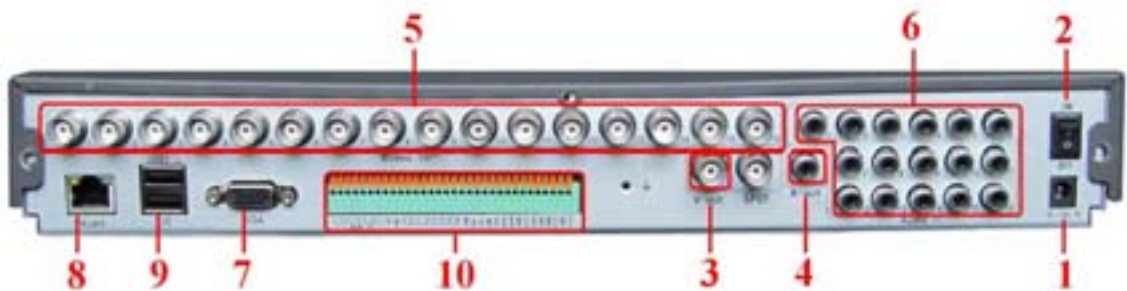

Connectors on Rear Panel

Item	Physical connector	Connector description
1	POWER input	DC 12V/3.42A
2	POWER SWITCH	POWER ON/OFF
3	Video output	One video output for connecting TV or monitor (BNC)
4	Audio Output	For connection audio output
5	Video input	For connecting analog video signal input (BNC)
6	Audio Input	For connecting audio signal

7	VGA	For connecting VGA monitor
8	Network	For connecting Ethernet
9	USB	USB2.0/USB mouse
10	Alarm Input	8 I/O alarm input
	Alarm Output	I/O output for alarm
	RS485	RS 485 for connecting PTZ

4.1.3 System Network Diagram



4.1.4 Connectors for Alarm

Peel off the color skin of the cable and then insert the cable into the slot on the rear panel DVR (The connection part for alarm). **NC may be considered COM**

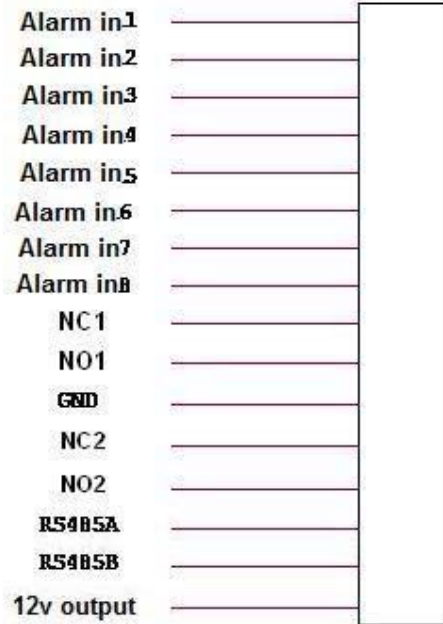

4.1.5 Alarm Input and Output

There are 8 sets alarm input connector and 1 set output for this DVR. Alarm input is for connection IR annunciator, fog sensor. The connection diagram of DC alarm input as following:

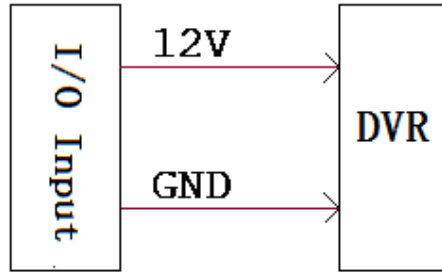

Connection diagram of AC alarm input as following:

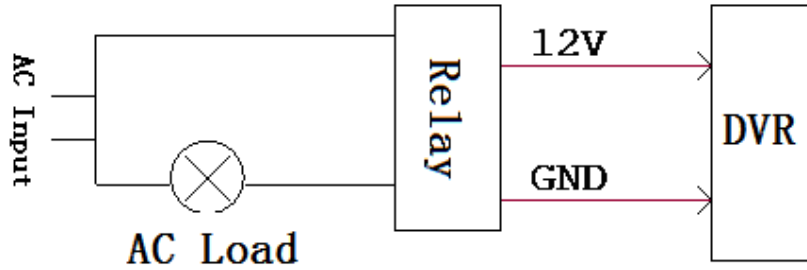

The connection diagram of alarm output as following:

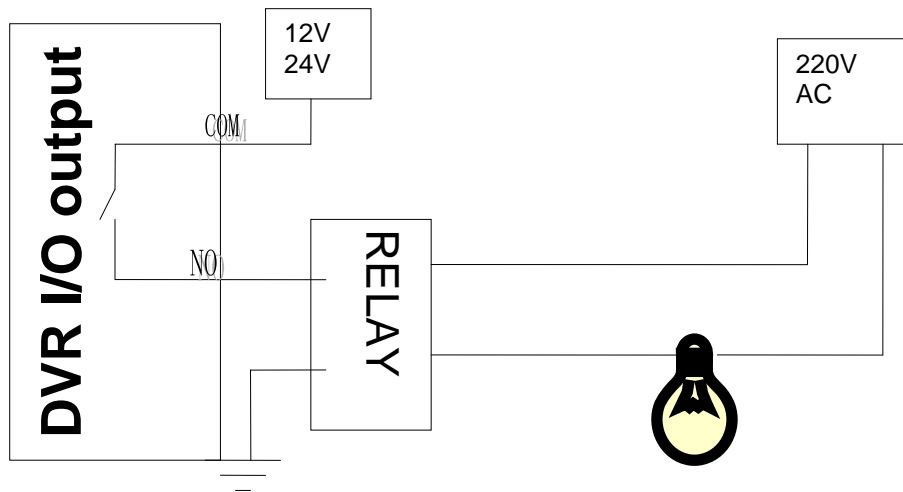

4.1.6 System Network Diagram

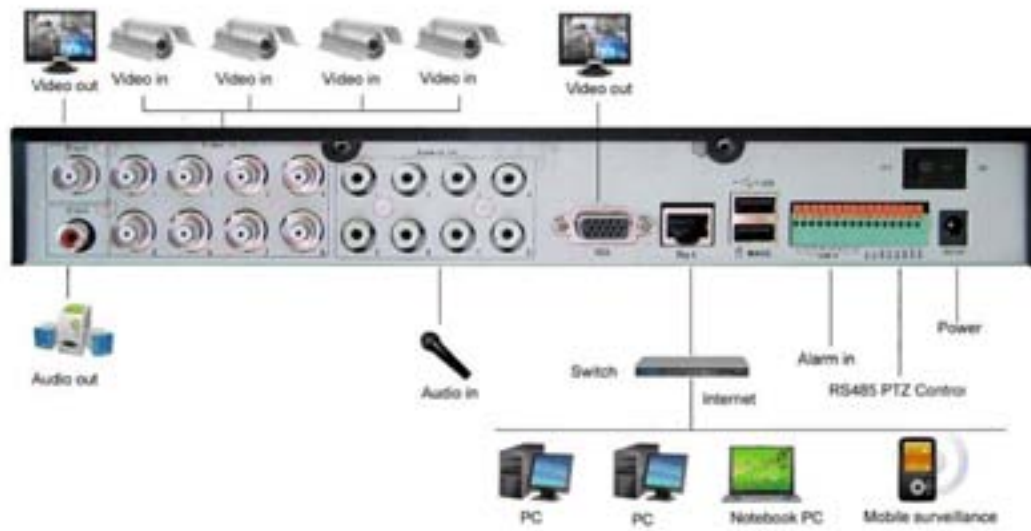

4.2 HDD INSTALLATION

Please installation the HDD as the following steps:

1) Open the machine, there are 4 screw holes used to fix the HDD as below;

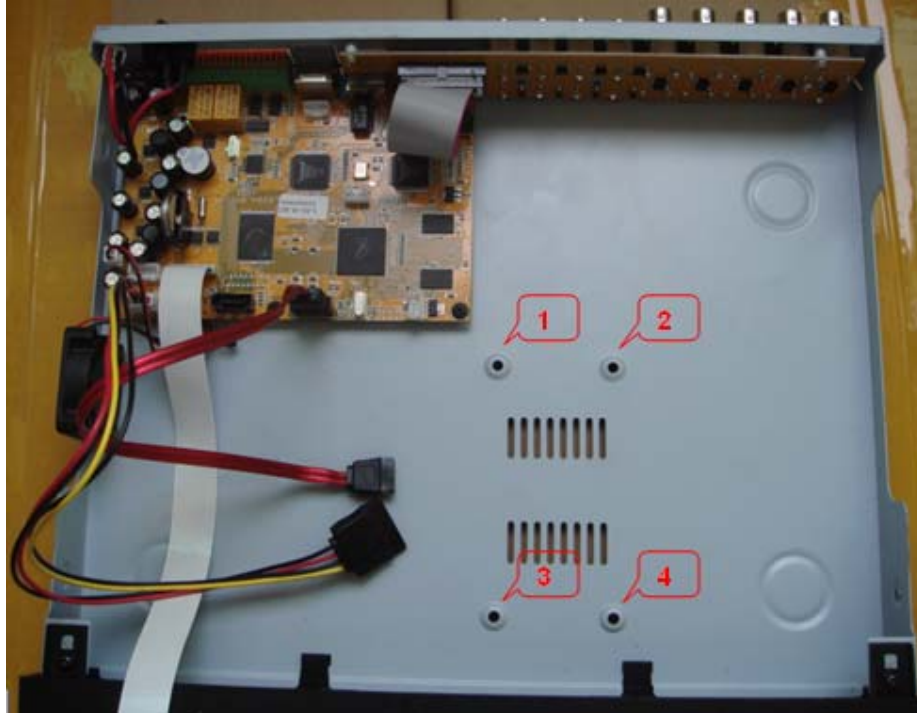

2) Take out the fixed screws and cotton pads used to protect HDD; As below picture;



3) Tear the cotton pads and post in the screw holes as shown;

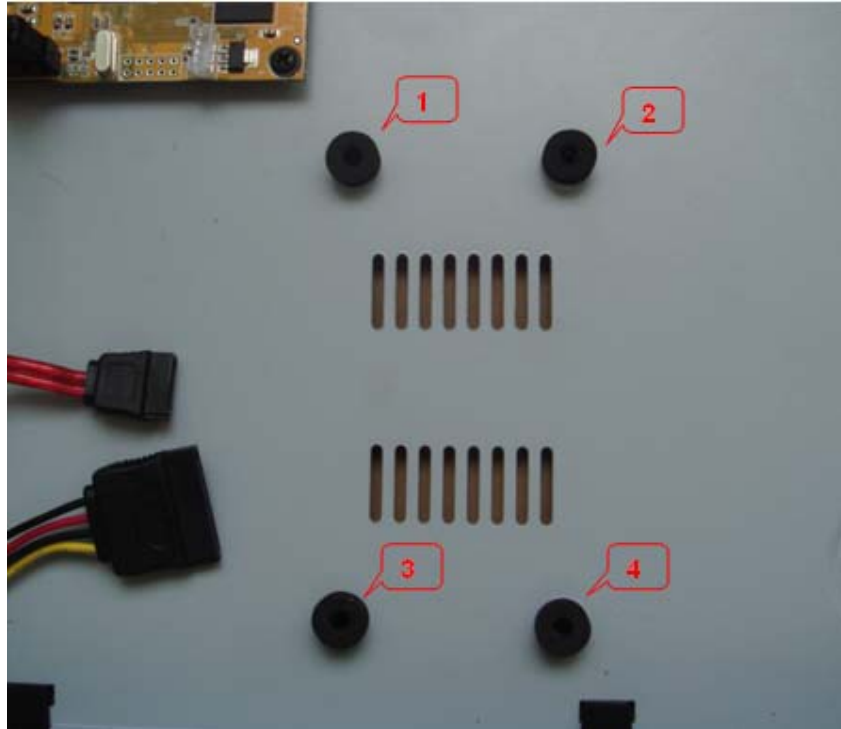

4) Put the circuit side of HDD on the board, and make the screw holes correspond to the cotton pads ;



5) Fix the HDD from the bottom; Make sure screws had gotten through the cotton pads, as below picture ;

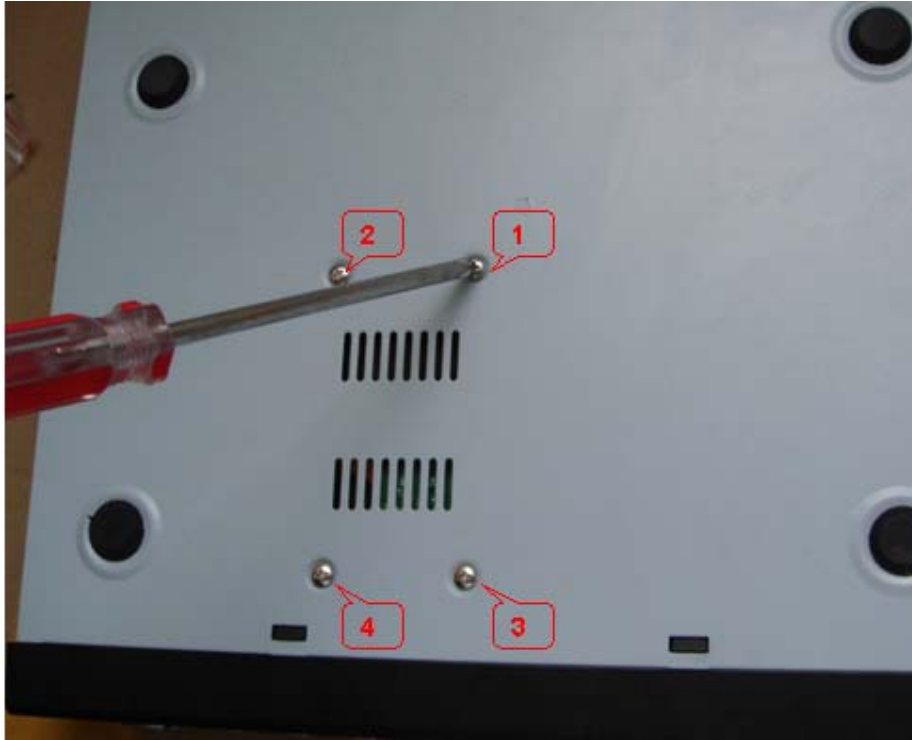

Notice: Newly installed HDD should format before recording

5. FAQ

If your problem is not listed below, please call our toll-free number for more support.

1. Question: DVR is not working after starting?

Answer:

- ✧ Check the adaptor input
- ✧ Check the on-off power line, is it well-connected?
- ✧ Check the power on-off
- ✧ Check the upgrade procedure
- ✧ Check the main board of DVR

2. Question: DVR is rebooting automatically or stopped after starting the DVR for several minutes?

Answer:

- ✧ Instability or low input voltage
- ✧ Bad track hard drive or the line of hard drive is bad
- ✧ On-off power supply is not enough
- ✧ The front-end video signal instability
- ✧ High temperature, too much dust, too bad the DVR operating environment
- ✧ The main board is not well-connected with other boards
- ✧ The hardware of DVR is defective

3. Question: No output of single channel, multi channel or all channel video?

Answer:

- ✧ Please check the adaptor of camera whether to see if it is well-connected
- ✧ Please check the cable for connecting video input/output in the back panel of DVR
- ✧ Please insert the video source directly into the display device and check If they are causing the problem.
- ✧ Check the brightness of the picture and bring it back to its original default setting
- ✧ No video input signal or too weak
- ✧ Display settings in the preview set to be closed
- ✧ The hardware of DVR is defective

4. Question: DVR cannot record after startup and the interface is showing "H"

Answer:

- ✧ Make sure power adaptor is DC 12V
- ✧ Make sure HDD is formatted
- ✧ Check the power and data connection cables of the HDD
- ✧ The HDD is defective
- ✧ The SATA port is not working

5. Question: What is meaning of "R" "M" "I" "H" showed in interface?

Answer:

- ✧ "R" means the channel is recording
- ✧ "M" means the channel is on motion detection
- ✧ "I" means the channel is on alarm
- ✧ "H" means there is either no HDD. the HDD is bad or the HDD is full

6. Question: DVR is having problem with real-time images, such as bad image color or serious brightness distortion

Answer:

- ✧ If PAL and NTSC is not correctly selected on the BNC output, the images will be in black and white
- ✧ DVR is not compatible with monitor
- ✧ The video transmission distance is too far
- ✧ The setting of DVR color, brightness and so on are wrong

7. Question: No audio sound when monitoring?

Answer:

- ✧ Check sound box or speaker functions. Also check possible short circuit.
- ✧ Audio source may be connected to the video channel. You can click to full-screen to

-
- check.
- ◇ The hardware of DVR is defective
- 8. Question: No audio sound when playing back?**
- Answer:
- ◇ Setting problem: open audio-video item
 - ◇ Check the audio to see if it is closed in playback interface
- 9. Question: System time is not correct?**
- Answer:
- ◇ Wrong setting or user did not click "Edit" to confirm
 - ◇ Battery is not connected properly
 - ◇ Battery is dead. Please change.
- 10. Question: Why the "Stop recording" by the right mouse button does not work, how to stop recording?**
- Answer:
- ◇ The "Stop recording" by the right mouse button is only suitable for Manual recording. It can't stop recording when it's in "start recording" or the video in video plan.
 - ◇ If you want to stop recording, please set the time is not recording.
- 11. Question: "Stop recording" function by the right mouse button does not work. How to stop recording?**
- Answer:
- The "Stop recording" by the right mouse button is for Manual Recording only. It can not stop recording when it is in "start recording" or the video is in video plan. If you want to stop recording, please set the time to not recoding.
- 12. Question: Motion detection is not working?**
- Answer:
- ◇ The setting of motion detection area is not correct
 - ◇ Sensitivity is too low
- 13. Question: CD-writer /USB backup error**
- Answer:
- ◇ The data exceeds the capacity of backup device
 - ◇ The backup device is incompatible
 - ◇ The backup device is damaged
- 14. Question: Remote control cannot work?**
- Answer:
- ◇ The address of remote control is not correct
 - ◇ The distance of remote control is too far or the angle is too biased
 - ◇ Remote control batteries run out
 - ◇ Remote control is damaged or the front panel of DVR is damaged
- 15. Question: WEB cannot login?**
- Answer:
- ◇ Please check the network to see if it is connected. Check if LINK or 100M LED is displayed normally on the panel; use ping xxx.xxx.xxx.xxx (DVR IP) to check if the Internet is linked properly.
 - ◇ Recommended to use Windows XP or Vista operating system, also use IE6.0 browser or IE7.0 browser
 - ◇ ActiveX control has been blocked. Please manually install ActiveX control again.
 - ◇ Please install DX8.1 and upgrade your video card driver
- 16. Question: There is no picture or picture is not clear when you preview the recording or playback the recording via IE**
- Answer:
- ◇ If you access DVR by IE, please choose "Wan" in "web environment"
 - ◇ Please try "Close windows" by the right mouse button, and try "Open windows" again
- 17. Question: It displays "other members are setting....." while setting DVR by IE**
- Answer:
- ◇ It probably means someone else is setting the DVR. Please check the DVR configuration interface or exit DVR.